

# Installation Instructions

## Gas Cooktops

Questions? Call us at 1.800.432.2737 or visit [GEAppliances.com](http://GEAppliances.com).  
In Canada, call 1.800.561.3344 or visit [GEAppliances.ca](http://GEAppliances.ca).

### IN THE COMMONWEALTH OF MASSACHUSETTS

- This product must be installed by a licensed plumber or gas fitter.

- When using ball type gas shut-off valves, they shall be the T-handle type.
- A flexible gas connector, when used, must not exceed 5 feet.

### ⚠ WARNING

#### FIRE OR EXPLOSION HAZARD

If the information in these instructions is not followed exactly, a fire or explosion may result causing property damage, personal injury or death.

Installation must be performed by a qualified installer.

Read these instructions completely and carefully.

Installation of this product must conform with local codes, or in the absence of local codes, with the National Fuel Gas Code, ANSI Z223.1/NFPA 54, latest edition. In Canada, installation must conform with the current Natural Gas Installation Code, CAN/CGA-B149.1 or the current Propane Installation Code, CAN/CGA-B149.2, and with local codes where applicable. This product has been design-certified by UL

according to ANSI Z21.1, latest edition and Canadian Gas Association according to CAN/CGA-1.1 latest edition.

When installing a gas appliance the use of old flexible connectors can cause gas leaks and personal injury. Always use a **NEW** flexible connector.

Leak testing of the appliance shall be conducted according to the manufacturer instructions.

The cooktop must be electrically grounded in accordance with local codes or, in the absence of local codes, in accordance with the National Electrical Code (ANSI/NFPA 70, latest edition). In Canada, electrical grounding must be in accordance with the current CSA C22.1 Canadian Electrical Code Part 1 and/or local codes. See Electrical Connections in this section.

Do not install this product with an air curtain hood or other cooktop hood that operates by blowing air down on the cooktop. This airflow may interfere with operation of the gas burners resulting in fire or explosion hazard.

### FOR YOUR SAFETY

### ⚠ WARNING

Before beginning the installation, switch power off at service panel and lock the service disconnecting means to prevent power from being switched on accidentally. When the service disconnecting means cannot be locked, securely fasten a prominent warning device, such as a tag, to the service panel.

### TOOLS YOU WILL NEED



Phillips screwdriver



Flat-blade screwdriver



Pencil and ruler



Safety Glasses



Open-end or adjustable wrench

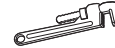

Pipe wrenches (2) (one for backup)



1/8" Drill Bit & Electric or Hand Drill

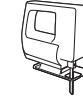

Saber Saw

### MATERIALS YOU MAY NEED

- Gas line shut-off valve
- Pipe joint sealant or UL-approved pipe thread tape with Teflon\* that resists action of natural and propane gases.
- Flexible metal appliance connector (1/2" I.D.). A 5-foot length is recommended for ease of installation but other lengths are acceptable. Never use an old connector when installing a new cooktop.
- Flare union adapter for connection to gas supply line (3/4" or 1/2" NPT x 1/2" I.D.).
- Flare union adapter for connection to pressure regulator on cooktop (1/2" NPT x 1/2" I.D.).
- Liquid leak detector or soapy water.

\*Teflon: Registered trademark of DuPont

### BEFORE YOU BEGIN

**IMPORTANT** — Save these instructions for local inspector's use.

**IMPORTANT** — Observe all governing codes and ordinances.

**IMPORTANT** — Remove all packing material and literature before connecting gas and electrical supply to cooktop.

**IMPORTANT** — To avoid damage to your cabinets, check with your builder or cabinet supplier to make sure that the materials used will not discolor, delaminate or sustain other damage. This product has been designed in accordance with the requirements of UL and CSA International and complies with the maximum allowable wood cabinet temperatures of 194°F (90°C).

**Note to Installer** — Be sure to leave these instructions with consumer.

**Note to consumer** — Keep these instructions for future reference.

**Service** — The electrical diagram is located inside the cooktop.

Proper installation is the responsibility of the installer.

Product failure due to improper installation is not covered under warranty.

#### Mobile Home - Additional Installation Requirements

The installation of this product must conform to the Manufactured Home Construction and Safety Standard, Title 24 CFR, Part 3280 (formerly the Federal Standard for Mobile Home Construction and Safety, Title 24, HUD Part 280). When such standard is not applicable, use the Standard for Manufactured Home Installations, ANSI A225.1/NFPA 501A or with local codes.

In Canada, the installation of this product must conform with the current standards CAN/CSA-A240-latest edition, or with local codes.

When this cooktop is installed in a mobile home, it must be secured during transit. Any method of securing the cooktop is adequate as long as it conforms to the standards listed above.

## DIMENSIONS AND CLEARANCES

Provide adequate clearances between the cooktop and adjacent combustible surfaces. These dimensions must be met for safe use of your cooktop.

Allow 30" (76.2 cm) minimum clearance between burners and bottom of unprotected wood or metal cabinet, or allow a 24" (61 cm) minimum when bottom of wood or metal cabinet is protected by no less than 1/4" (6.4 mm) thick flame-retardant millboard covered

with no less than No. 28 MSG sheet metal (.015" [.38 mm] thick), .015" (.38 mm) thick stainless steel, .025" (0.64 mm) aluminum or .020" (0.5 mm) copper.

Installation of a listed microwave oven or cooking appliance over the cooktop shall conform to the installation instructions packed with that appliance.

Built-in oven installation, shall conform to the installation instruction packed with the built-in oven.

## MAINTAIN THE FOLLOWING MINIMUM CLEARANCE DIMENSIONS

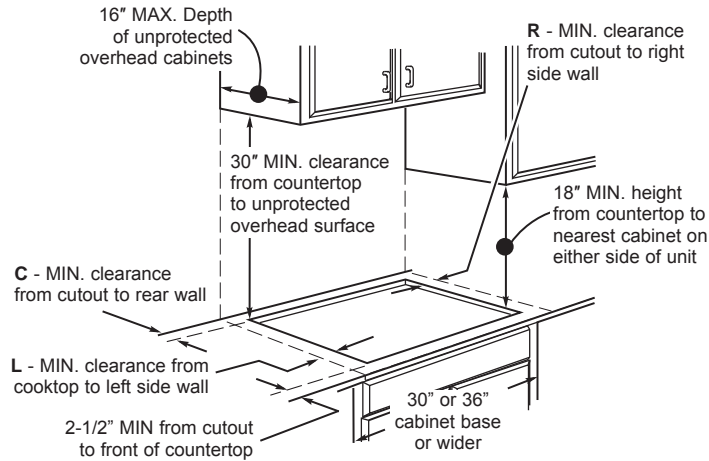

**ALL HORIZONTAL CLEARANCES MUST BE MAINTAINED FOR A MINIMUM OF 18" ABOVE THE COOKING SURFACE.**

	C	L	R
JGP3030, JGP3530, JGP3036	2-1/4"	6"	6"
JGP5030, PGP7030, CGP7030, PGP9030, CGP9530	2-7/8"	12"	12"
JGP5036, PGP7036, CGP7036, PGP9036, CGP9536	3-3/8"	12"	12"

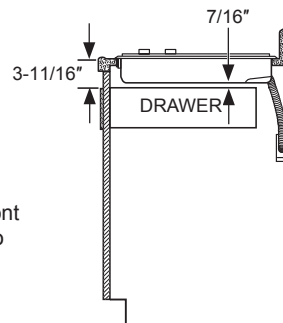

**NOTE:** Allow 7/16" minimum vertical clearance from the cooktop bottom (or 3-11/16" minimum depth from the countertop) to any combustible surfaces, such as a cabinet drawer.

For island installation, maintain 2-1/2 in. minimum from cutout to front and back edge of countertop. Maintain 3 in. minimum from cutout to side edges of countertop.

1" = 2.5 cm; 1' = 0.3 m

## OVERALL COOKTOP DIMENSIONS

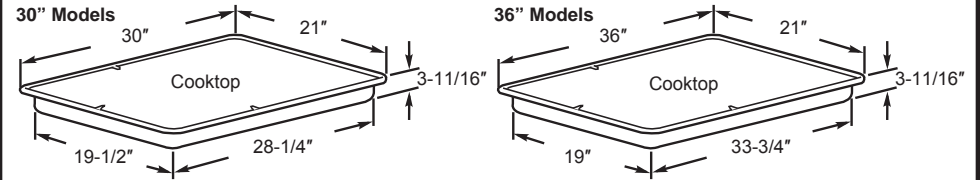

## CUTOUT DIMENSIONS OF COUNTERTOP

To ensure accuracy, it is best to make a template when cutting the opening in the counter.

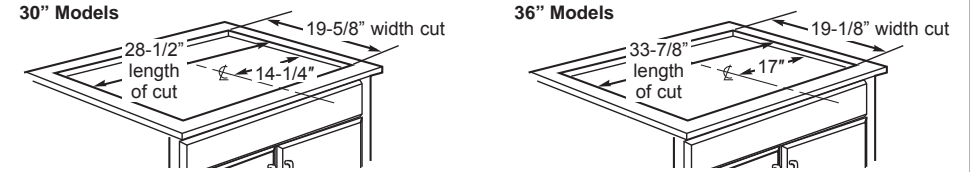

## RECOMMENDED GAS SUPPLY LOCATION FROM BACKWALL

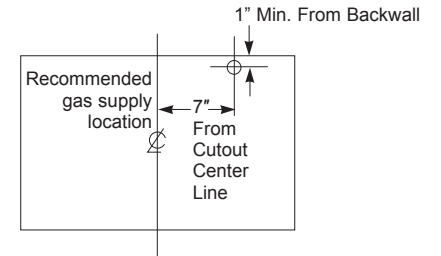

## FOR AMERICANS WITH DISABILITIES ACT (ADA) FORWARD APPROACH INSTALLATION ONLY

**NOTE:** The enclosure must be made of wood material. Also, an access panel is required for the electrical outlet, pressure regulator, shut-off valve, hold-down brackets, and service.

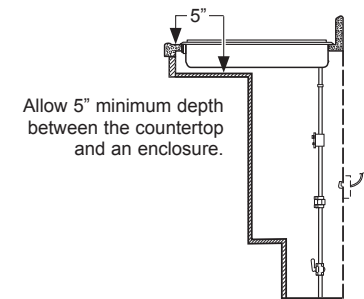

## CONVERTING TO PROPANE GAS (OR CONVERTING BACK TO NATURAL GAS FROM PROPANE)

**This cooktop leaves the factory set for use with natural gas. If you want to convert to propane gas, the conversion must be performed by a qualified propane gas installer.**

The conversion orifices and instructions can be found attached to the regulator.

Keep these instructions and all orifices in case you want to convert back to natural gas.

# 1 INSTALLING THE COOKTOP

## ⚠ WARNING

Do not remove the 6 black Z brackets screwed to the bottom of the cooktop (on some models).

- Locate electrical outlet and gas shut-off valve beneath cabinet.
- Lay cooktop upside down on a towel or tablecloth covered countertop.
- Locate and remove hold-down brackets from literature package.
- Attach brackets to cooktop. Remove the screw from the side of the cooktop and screw the hold-down bracket to the side of the cooktop unit. Repeat for opposite side of cooktop.
- Insert the cooktop centered into the cutout opening. Make sure the front edge of the countertop is parallel to the cooktop. Make final check that all required clearances are met.

Once the unit is in place, screw the hold-down bracket into the cabinet sides to secure the unit into place.

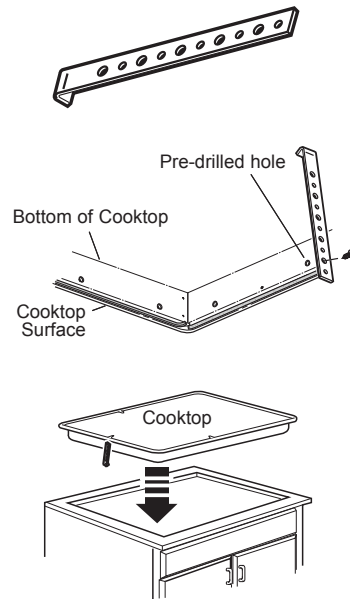

# 2 GAS SUPPLY

## ⚠ WARNING

**Fire Hazard: Do not use a flame to check for gas leaks.**

## ⚠ WARNING

**Explosion Hazard: Do not exceed 25 ft-lbs of torque when making gas line connections. Overtightening may crack the pressure regulator resulting in fire or explosion hazard.**

### Gas Pressure Regulator

You must use the gas pressure regulator supplied with this range. For proper operations the inlet pressure to the regulator should be as follows:

#### Natural Gas:

Minimum pressure: 6" of Water Column

Maximum pressure: 13" of Water Column

#### Propane Gas:

Minimum pressure: 11" of Water Column

Maximum pressure: 13" of Water Column

If you are not sure about the inlet pressure contact local gas supplier.

**Shut off the main gas supply valve before disconnecting the old cooktop and leave it off until the new hook-up has been completed. Don't forget to relight the pilot on other gas appliances when you turn the gas back on.**

Because hard piping restricts movement of the range, the use of a CSA International-certified flexible metal appliance connector is recommended unless local codes require a hard-piped connection.

If the hard piping method is used, you must carefully align the pipe; the cooktop cannot be moved after the connection is made.

To prevent gas leaks, apply pipe joint compound or wrap pipe thread tape with Teflon\* around all male (external) pipe threads.

- Install provided regulator in the gas line between the cooktop and manual shut-off valve. Refer to the arrow on the back of the regulator for gas flow direction. Ensure the front of the regulator is facing towards the cabinet front, easily accessible through the cabinet doors.
- Install a manual shut-off valve in the gas line in a location easily accessible through the cabinet doors.
- When all connections have been made, ensure all gas controls are in the off position and turn on the main gas supply valve. Use a liquid leak detector at all joints and connections to check for leaks in the system.

When using pressures greater than 1/2 psig to pressure test the gas supply system of the residence, disconnect the cooktop and individual shut-off valve from the gas supply piping. When using pressures of 1/2 psig or less to pressure test the gas supply system, simply isolate the cooktop from the gas supply system by closing the individual shut-off valve.

When checking for proper operation of the regulator, the inlet pressure must be at least 1" greater than the operating (manifold) pressure as given on rating label of product.

\*Teflon: Registered trademark of DuPont

## CONNECTOR HOOKUP

TYPICAL INSTALLATION WITH NO OBSTRUCTION BELOW COOKTOP

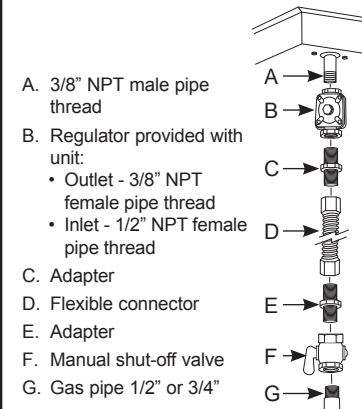

ALTERNATE INSTALLATION WITH OBSTRUCTION BELOW COOKTOP

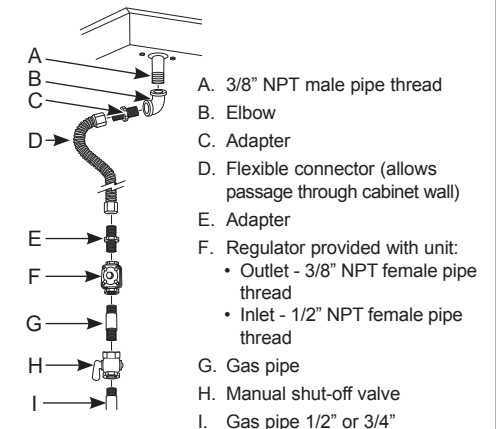

### 3 ELECTRICAL CONNECTIONS

#### ⚠ WARNING

**Shock Hazard: This appliance must be properly grounded. Failure to do so can result in electric shock.**

**Electrical Requirements** - 120-volt, 60 Hertz, properly grounded circuit protected by a 15-amp or 20-amp circuit breaker or time delay fuse. It is recommended that a separate circuit serving only this cooktop be provided.

**NOTE:** Use of automatic, wireless, or wired external switches that shut off power to the appliance are not recommended for this product.

#### Grounding

The power cord of this appliance is equipped with a three-prong (grounding) plug which plugs into a standard three-prong grounding wall receptacle to minimize the possibility of electric shock hazard from this appliance.

The customer should have the wall receptacle and circuit checked by a qualified electrician to make sure the receptacle is properly grounded.

Where a standard two-prong wall receptacle is encountered, it is the personal responsibility and obligation of the customer to have it replaced with a properly grounded three-prong wall receptacle.

**DO NOT, UNDER ANY CIRCUMSTANCES, CUT OR REMOVE THE THIRD (GROUND) PRONG FROM THE POWER CORD. DO NOT USE AN ADAPTER. DO NOT USE AN EXTENSION CORD.**

Ground Fault Circuit Interrupters (GFCI's) are not required or recommended for gas cooktop receptacles. Performance of the cooktop will not be affected if operated on a GFCI-protected circuit but occasional nuisance tripping of the GFCI breaker is possible.

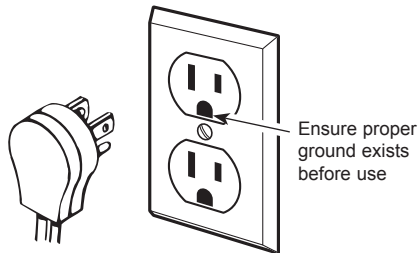

### 4 SURFACE BURNERS

#### ⚠ WARNING

**Fire or Explosion Hazard: Do not operate the burner without all burner parts in place.**

- Burners** - Place surface burners into corresponding positions on cooktop.
- Caps** - Place caps on proper size burner.
- Grates** - Place the grates on the cooktop.

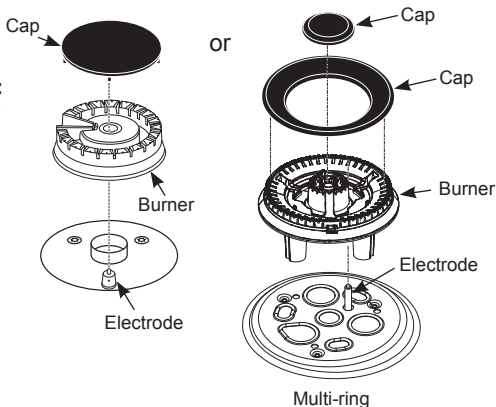

Grates  
(on some models)

Grates  
(on some models)

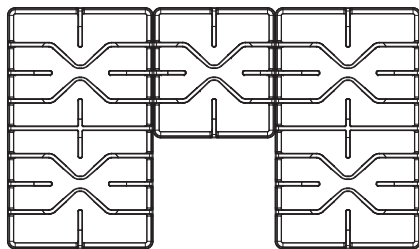
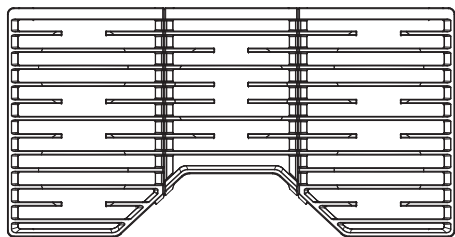

### 5 CHECK SURFACE BURNERS

Push and turn a knob to the LITE position. A clicking sound indicates proper operation of the ignition system. When lighting any burner, sparks will appear at all burners but gas flows from only the one selected. Once air is purged from the supply line, burner should light within 4 seconds. After burner lights, rotate the knob out of the LITE position. Try each burner in succession until all burners have been checked.

#### Quality of Flames

Determine the quality of flames visually. Normal burner flames should look like (A) or (B).



(A) Soft blue flames—  
Normal for natural gas



(B) Yellow tips on  
outer cones—  
Normal for propane gas

Long, bright yellow flames are not normal. Normal flames may show signs of an orange tint when well heated or signs of flickering orange due to particles in the gas or air.

### WHEN ALL HOOKUPS ARE COMPLETED

Make sure all controls are left in the off position. Make sure the flow of combustion and ventilation air to the cooktop is unobstructed.

Check that all packing materials and tape have been removed. This will include adhesive tape, wire ties, cardboard and protective plastic. Failure to remove these materials could result in damage to the appliance once the appliance has been turned on and surfaces have heated.

### INSTALLATION AT HIGH ALTITUDE

Over 6000ft, product configured for natural gas or propane requires installation of kit (WB28X29862 for natural gas and WB28X29861 for propane gas). Follow the instructions included with the kit.

1" = 2.5 cm; 1' = 0.3 m

### INSTALLATION INSTRUCTION

31-11089-1 11-18 GEA

JGP3030, JGP3530, JGP5030, PGP7030, PGP9030, CGP9530, JGP3036, JGP5036, PGP7036, CGP7030, PGP9036, CGP7036, CGP9536