



# Dryers

**Safety Instructions**..... 2-3

**Operating Instructions** .. 4-11  
 Control Panels ..... 5-7  
 Dryer Features..... 8  
 Loading and Using the Dryer..... 10  
 Venting the Dryer ..... 11

**Troubleshooting Tips** ... 12, 13

**Consumer Support**  
 Consumer Support ..... 16  
 Warranty ..... 15

Owner's Manual



Write the model and serial number here:

Model # \_\_\_\_\_

Serial # \_\_\_\_\_

You can find them on a label on the front of the dryer behind the door.



**234D2431P009**

29-6337 08-19 Printed in Mexico

# IMPORTANT SAFETY INFORMATION.

## READ ALL INSTRUCTIONS BEFORE USING.

 This is the safety alert symbol. This symbol alerts you to potential hazards that can kill you or hurt you and others. All safety messages will follow the safety alert symbol and the word "DANGER", "WARNING", or "CAUTION." These words are defined as:

 **DANGER**

Indicates a hazardous situation which, if not avoided, **will** result in death or serious injury.

 **WARNING**

Indicates a hazardous situation which, if not avoided, **could** result in death or serious injury.

 **CAUTION**

Indicates a hazardous situation which, if not avoided, **could** result in minor or moderate injury.

## IMPORTANT SAFETY INSTRUCTIONS

 **WARNING**

To reduce the risk of fire, explosion, electric shock, or injury to persons when using your appliance, follow basic precautions, including the following:

- Read all instructions before using the appliance.
- DO NOT dry articles that have been previously cleaned in, washed in, soaked in or spotted with gasoline, dry-cleaning solvents, or other flammable or explosive substances, as they give off vapors that could ignite or explode.
- DO NOT place items exposed to cooking oils in your dryer. Items contaminated with cooking oils may contribute to a chemical reaction that could cause a load to catch fire.
- DO NOT allow children to play on or in this appliance. Close supervision of children is necessary when this appliance is used near children. Before the appliance is removed from service or discarded, remove the door to the drying compartment.
- DO NOT reach into the appliance if the drum is moving.
- DO NOT install or store this appliance where it will be exposed to the weather.
- DO NOT tamper with controls, repair or replace any part of this appliance or attempt any servicing unless specifically recommended in the user maintenance instructions or in published user repair instructions that you understand and have the skills to carry out.
- DO NOT use fabric softeners or products to eliminate static unless recommended by the manufacturer of the fabric softener or product.
- DO NOT use heat to dry articles containing foam rubber or similarly textured rubber-like materials
- Clean lint screen before or after each load. DO NOT operate the dryer without the lint filter in place
- Do not store combustible materials, gasoline or other flammable liquids near the dryer. Keep area around the exhaust opening and adjacent surrounding areas free from the accumulation of lint, dust and dirt. Keep dryer area clear and free from items that would obstruct the flow of combustion and ventilation air.
- The interior of the appliance and exhaust duct should be cleaned periodically by qualified service personnel
- Unplug the appliance or turn off the circuit breaker before servicing. Pressing the **Power** or **Start/Pause** button DOES NOT disconnect power.
- DO NOT operate this appliance if it is damaged, malfunctioning, partially disassembled, or has missing or broken parts, including a damaged cord or plug.
- DO NOT spray any type of aerosol into, on or near dryer at any time. Do not use any type of spray cleaner when cleaning dryer interior. Hazardous fumes or electrical shock could occur.
- See "Electrical Connection" located in the Installation Instructions for grounding instructions.

## SAVE THESE INSTRUCTIONS

## ADDITIONAL GAS DRYER WARNINGS

**WARNING**

For your safety, the information in this manual must be followed to minimize the risk of fire or explosion or to prevent damage, personal injury, or death.

- DO NOT store or use gasoline or other flammable vapors and liquids in the vicinity of this or any other appliance.
- WHAT TO DO IF YOU SMELL GAS:
  - DO NOT try to light any appliance.
  - DO NOT touch any electrical switch; DO NOT use any phone in your building.
  - Clear the room, building, or area of any occupants.
  - Immediately call your gas supplier from a neighbor's phone. Follow the gas supplier's instructions.
  - If you cannot reach your gas supplier, call the fire department.
- Installation and service must be performed by a qualified installer, service agency, or the gas supplier.

### *State of California Proposition 65 Warnings:*

The California Safe Drinking Water and Toxic Enforcement Act requires the governor of California to publish a list of substances known to the state to cause cancer, birth defects or other reproductive harm and requires businesses to warn of potential exposure to such substances.

**WARNING**

This product contains one or more chemicals known to the State of California to cause cancer, birth defects or other reproductive harm.

Gas appliances can cause low-level exposure to some of these substances, including benzene, carbon monoxide, formaldehyde and soot, caused primarily by the incomplete combustion of natural gas or LP fuels. Exposure to these substances can be minimized by properly venting the dryer to the outdoors.

**SAVE THESE INSTRUCTIONS**

# Operating instructions

## **⚠ WARNING!**

To reduce the risk of fire, electric shock, or injury to persons, read the **IMPORTANT SAFETY INSTRUCTIONS** before operating this appliance.

### **⚠ WARNING**



#### **Explosion Hazard**

Keep flammable materials and vapors, such as gasoline, away from dryer.  
DO NOT dry anything that has ever had anything flammable on it (even after washing).  
Failure to do so can result in death, explosion, or fire.

### **⚠ WARNING**



#### **Fire Hazard**

No washer can completely remove oil.  
Do not dry anything that has ever had any type of oil on it (including cooking oils).  
Items containing foam, rubber, or plastic must be dried on a clothesline or by using an air dry cycle.  
Failure to follow these instructions can result in death or fire.

Throughout this manual, features and appearance may vary from your model

## Quick Start Guide

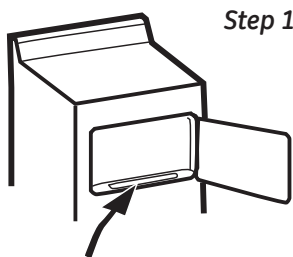

Step 1

- Clean lint filter

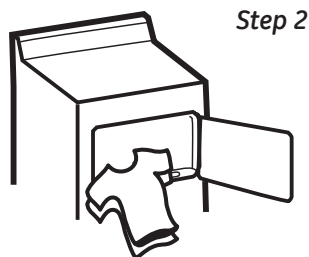

Step 2

- Add clothes
- Shut door

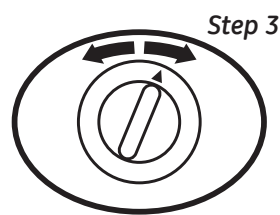

Step 3

- Select drying cycle

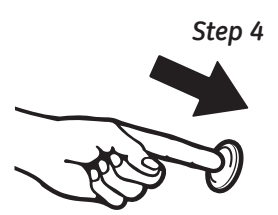

Step 4

- Push Start

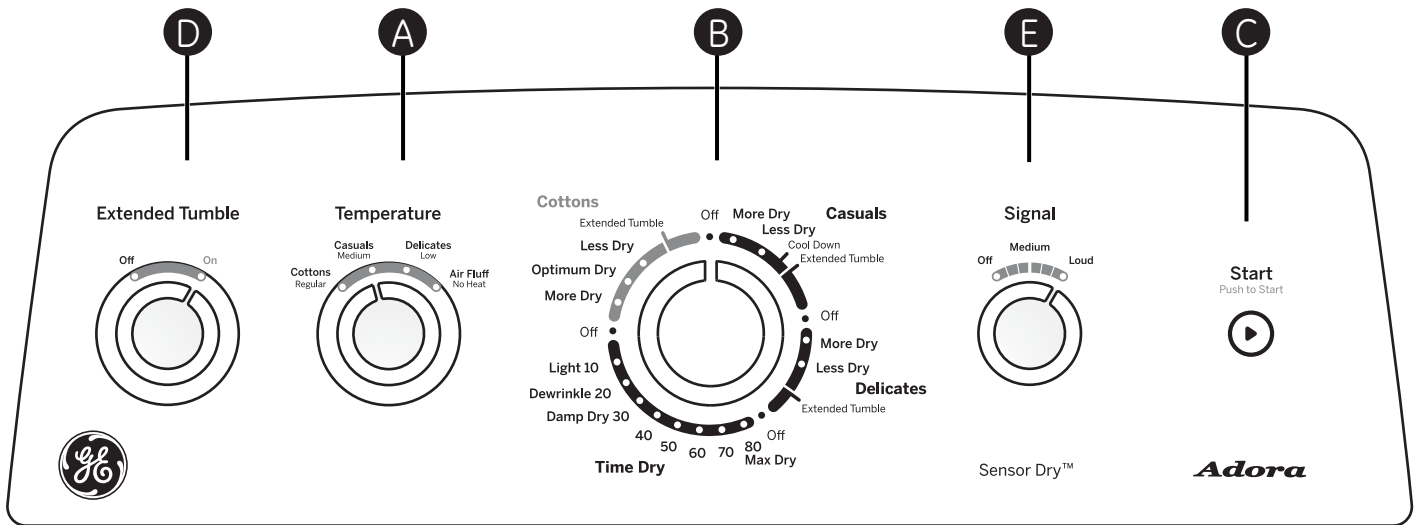
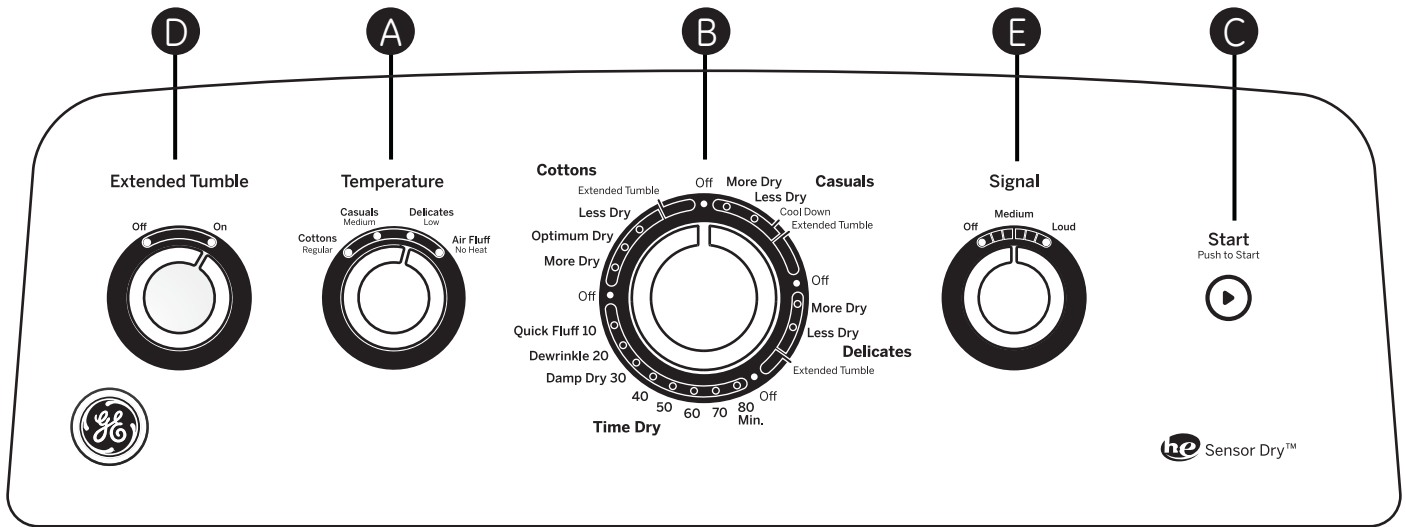

---

**IMPORTANT: Clean the lint filter each time you use the dryer.**

**A Temperature** (Not all features are on all models)

---

**Cottons Regular** For regular to heavy cottons.

---

**Casuals Medium** For synthetics, blends, delicates and items labeled permanent press.

---

**Delicates Low** On some models. For delicates, synthetics and items labeled tumble dry low.

---

**Air Fluff No Heat** For fluffing items without heat. Use the **Time Dry** cycle.

**B Drying Cycles** (Not all features are on all models)

---

**Cottons** For cottons and most linens. For most loads, select **Optimum Dry** (on some models).

---

**Casuals** For wrinkle-free, permanent press and delicate items, and knits.

---

**Delicates** For delicate items, special-care fabrics and knits.

---

**Time Dry** Set the Cycle Selector at the desired drying time.

---

**Dewrinkle** For removing wrinkles from items that are clean and dry or that are very lightly damp.

---

**Quick Fluff / Light** For freshening or fluffing up already dry clothing, fabrics, linens and pillows. Use with **Air Fluff No Heat**. Provides 10 minutes of no heat tumbling.

*Sensor cycles automatically determine fabric dryness. Select **Less Dry** if you want your clothes slightly damp at the end of the drying cycle. Select **More Dry** if you want them to feel drier.*

*Timed cycles run for a selected time.*

**C Start**—Close the dryer door. Select **Start**. Opening the door during operation will stop the dryer. To restart the dryer, close the door and select **Start** to complete the cycle.

---

**NOTE: Drying times will vary according to the type of heat used (Electric, Natural or LP gas), size of load, types of fabrics, wetness of clothes and condition of exhaust ducts.**

**D Extended Tumble Option** (on some models)

Use this option to minimize the wrinkles in clothes. It provides approximately 15 minutes of no-heat tumbling after the clothes are dry.

This option can only be used with the **Cottons** and **Casuals/Easy Care** cycles.

If you are using the cycle **Signal** knob and you select the **Extended Tumble** option, a signal will sound at the end of the drying time and several times during the **Extended Tumble** cycle. This will remind you that it is time to remove the clothes.

If **Extended Tumble** is not on, the dryer will stop once the timer reaches the **Extended Tumble** mark on the cycle dial.

---

**E Cycle Signal Option** (on some models)

This signal will sound just before the end of the cycle to remind you to remove the clothes. On some models, the signal sound level cannot be adjusted.

If you selected the **Extended Tumble** option, the signal will sound at the end of the drying time and will sound several times during the **Extended Tumble** cycle. This will remind you that it is time to remove the clothes.

**NOTE:**

- **Remove garments promptly at the sound of the signal. Place clothes on hangers so wrinkles won't set in.**
- **Use the cycle Signal especially when drying fabrics like polyester knits and permanent press. These fabrics should be removed so wrinkles won't set in.**

---

**Automatic Cycle Signal** (on some models)

At the end of each cycle, there is approximately 15 minutes of no-heat tumbling after the laundry is dry. A reminder signal will sound periodically during this time to remind you to remove the laundry.

## About the dryer features.

---

### **Sensor Dry** (SOME MODELS)

#### **Sensor Dry**

This feature is active in all cycles except **Timed Dry**, **Warm Up** and **Air Fluff**.

The **Sensor Dry** provides greater drying accuracy than standard machines, resulting in shorter dry times and better clothes care. As the clothes tumble, they touch a moisture sensor. The sensor will stop the heating cycle as soon as the clothes have reached the selected dryness.

This dryer will adjust the initial estimated drying time of the sensor dry cycles as it “learns” its installation and usage profile. Please allow several weeks for the dryer to customize itself to “you”.

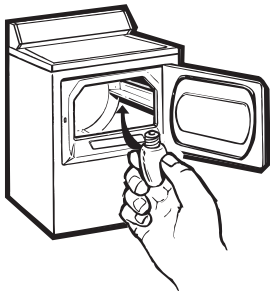

#### **Drum Lamp**

Before replacing the light bulb, be sure to unplug the dryer power cord or disconnect the dryer at the household distribution panel by removing the fuse or switching off the circuit breaker. Reach above dryer opening from inside the drum. Remove the bulb and replace with the same size bulb.

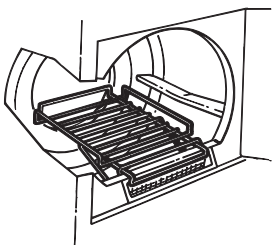

#### **Drying Rack** (on some models)

A handy drying rack may be used for drying delicate items such as washable sweaters.

Hook the rack over the lint filter so the rack extends into the dryer drum.

#### **NOTE:**

- The drying rack must be used with the **Timed Cycle**.
- Do not use this drying rack when there are other clothes in the dryer.

#### **Alloy Steel Drum** (on some models)

The alloy steel used to make the dryer drum provides the highest reliability available in a GE dryer. If the dryer drum should be scratched or dented during normal

use, the drum will not rust or corrode. These surface blemishes will not affect the function or durability of the drum.

# About loading and using the dryer.

Always follow the fabric manufacturer's care label when laundering



## Sorting and Loading Hints

As a general rule, if clothes are sorted properly for the washer, they are sorted properly for the dryer.

Do not add fabric softener sheets once the load has become warm. They may cause fabric softener stains. Bounce® Fabric Conditioner Dryer Sheets have been approved for use in all GE Dryers when used in accordance with the manufacturer's instructions.

**Do not overload.** This wastes energy and causes wrinkling.

**Do not dry the following items:** fiberglass items, woolens, rubber-coated items, plastics, items with plastic trim and foam-filled items.



## Fabric Care Labels

Below are fabric care label "symbols" that affect the clothing you will be laundering

### WASH LABELS

<b>Machine wash cycle</b>						
<b>Water temperature</b>						

### BLEACH LABELS

<b>Bleach symbols</b>			
-----------------------	--	--	--

### DRY LABELS

<b>Tumble dry</b>						
<b>Heat setting</b>						
<b>Special instructions</b>						



## Care and Cleaning of the Dryer

**The Exterior:** Wipe or dust any spills or washing compounds with a damp cloth. Dryer control panel and finishes may be damaged by some laundry pretreatment soil and stain remover products. Apply these products away from the dryer. The fabric may then be washed and dried normally. Damage to your dryer caused by these products is not covered by your warranty

**The Lint Filter:** Clean the lint filter before each use. Remove by pulling straight up. Run your fingers across the filter. A waxy buildup may form on the lint filter from using dryer added fabric softener sheets.

To remove this buildup, wash the lint screen in warm, soapy water. Dry thoroughly and replace. Do not operate the dryer without the lint filter in place.

Vacuum the lint from the dryer lint filter area if you notice a change in dryer performance

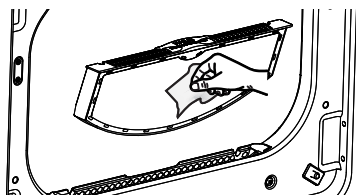

**Stainless Steel:** To clean stainless steel surfaces, use a damp cloth with a mild, non-abrasive cleaner suitable for stainless steel surfaces. Remove the cleaner residue, and then dry with a clean cloth.

**Dryer Interior and Duct:** The interior of the appliance and exhaust duct should be cleaned once a year by qualified service personnel.

**The Exhaust Duct:** Inspect and clean the exhaust ducting at least once a year to prevent clogging. A partially clogged exhaust can lengthen the drying time.

### Follow these steps:

- 1 Turn off electrical supply by disconnecting the plug from the wall socket.
- 2 Disconnect the duct from the dryer.
- 3 Vacuum the duct with the hose attachment and reconnect the duct.

**The Exhaust Hood:** Check from the outside that the flaps of the hood move freely when operating. Make sure that there is not wildlife (birds, insects, etc.) nesting inside the duct or hood.



For the best drying performance, the dryer needs to be properly vented **The dryer will use more energy and run longer if it is not vented to the below specifications. Carefully follow the details on Exhausting in the Installation Instructions.**

- Use only rigid metal 4" diameter ductwork inside the dryer cabinet Use only rigid metal or UL listed flexible metal 4" diameter ductwork for exhausting to the outside.
- Do not use plastic or other combustible ductwork.
- Use the shortest length possible.
- Do not crush or collapse.
- Avoid resting the duct on sharp objects.
- **Venting must conform to local building codes.**

**⚠ WARNING**  - Fire Hazard

This dryer **MUST** be exhausted to the outdoors.

Use only 4" rigid metal ducting for the home exhaust duct.

Use only 4" rigid metal or UL-listed dryer transition duct to connect the dryer to the home exhaust.

**DO NOT** use a plastic vent.

**DO NOT** exhaust into a chimney, kitchen exhaust, gas vent, wall, ceiling, attic, crawl space, or concealed space of a building.

**DO NOT** install a screen in or over the exhaust duct.

**DO NOT** use duct longer than specified in the exhaust length table.

Failure to follow these instructions can result in death or fire.

**Correct Venting**

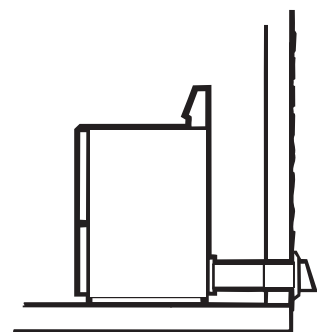
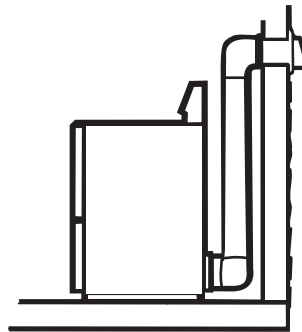

**Incorrect Venting**

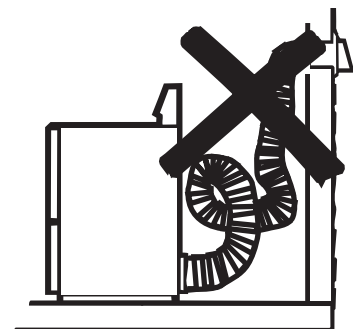
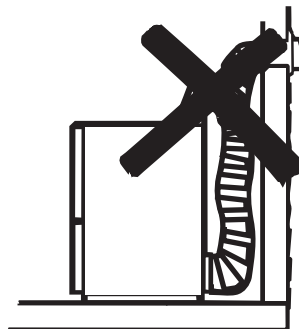

## Before you call for service...



*Troubleshooting Tips*  
Save time and money! Review the charts on the following pages, or visit [GEAppliances.ca](http://GEAppliances.ca). You may not need to call for service.

<b>Problem</b>	<b>Possible Causes</b>	<b>What To Do</b>
<b>Dryer doesn't start</b>	<b>Dryer is unplugged</b>	<ul style="list-style-type: none"> <li>• Make sure the dryer plug is pushed completely into the outlet.</li> </ul>
	<b>Fuse is blown/circuit breaker is tripped</b>	<ul style="list-style-type: none"> <li>• Check the house fuse/circuit breaker box and replace fuse or reset breaker. <b>NOTE:</b> Most electric dryers use two fuses/breakers.</li> </ul>
<b>Dryer doesn't heat</b>	<b>Fuse is blown/circuit breaker is tripped; the dryer may tumble but not heat</b>	<ul style="list-style-type: none"> <li>• Check the house fuse/circuit breaker box and replace both fuses or reset both breakers. Your dryer may tumble if only one fuse is blown or one breaker is tripped.</li> </ul>
	<b>Gas service is off</b>	<ul style="list-style-type: none"> <li>• Make sure gas shutoff at dryer and main shutoff are fully open.</li> </ul>
	<b>No heat temperature selected</b>	<ul style="list-style-type: none"> <li>• Select another heat setting.</li> </ul>
<b>Dryer shakes or makes noise</b>	<b>Some shaking/noise is normal. Dryer may be sitting unevenly</b>	<ul style="list-style-type: none"> <li>• Move dryer to an even floor space, or adjust leveling legs as necessary until even.</li> </ul>
<b>Greasy spots on clothes</b>	<b>Improper use of fabric softener</b>	<ul style="list-style-type: none"> <li>• Follow directions on fabric softener package.</li> </ul>
	<b>Drying dirty items with clean ones</b>	<ul style="list-style-type: none"> <li>• Use your dryer to dry only clean items. Dirty items can stain clean items and the dryer.</li> </ul>
	<b>Clothes were not completely clean</b>	<ul style="list-style-type: none"> <li>• Sometimes stains which cannot be seen when the clothes are wet appear after drying. Use proper washing procedures before drying.</li> </ul>
<b>Lint on clothes</b>	<b>Lint filter is full</b>	<ul style="list-style-type: none"> <li>• Clean lint screen before each load.</li> </ul>
	<b>Improper sorting</b>	<ul style="list-style-type: none"> <li>• Sort lint producers (like chenille) from lint collectors (like corduroy).</li> </ul>
	<b>Static electricity can attract lint</b>	<ul style="list-style-type: none"> <li>• See suggestions in this section under <b>Static</b>.</li> </ul>
	<b>Overloading</b>	<ul style="list-style-type: none"> <li>• Separate large loads into smaller ones.</li> </ul>
	<b>Paper, tissue, etc., left in pockets</b>	<ul style="list-style-type: none"> <li>• Empty all pockets before laundering clothes.</li> </ul>
<b>Static occurs</b>	<b>No fabric softener was used</b>	<ul style="list-style-type: none"> <li>• Try a fabric softener.</li> <li>• Bounce® Fabric Conditioner Dryer Sheets have been approved for use in all GE Dryers when used in accordance with the manufacturer's instructions.</li> </ul>
	<b>Over-drying</b>	<ul style="list-style-type: none"> <li>• Try a fabric softener.</li> <li>• Adjust setting to <b>Less Dry</b> or <b>Damp Dry</b>.</li> </ul>
	<b>Synthetics, permanent press and blends can cause static</b>	<ul style="list-style-type: none"> <li>• Try a fabric softener.</li> </ul>
<b>Inconsistent drying times</b>	<b>Type of heat</b>	<ul style="list-style-type: none"> <li>• Automatic drying times will vary according to the type of heat used (electric, natural or LP gas), size of load, types of fabrics, wetness of clothes and condition of exhaust ducts.</li> </ul>
<b>The Dry dryness level was chosen but load is still damp</b>	<b>Load consists of a mixture of heavy and light fabrics</b>	<ul style="list-style-type: none"> <li>• When combining heavy and light fabrics in a load, choose <b>More Dry</b> if you are using a sensor cycle.</li> </ul>
	<b>Exhaust system is blocked</b>	<ul style="list-style-type: none"> <li>• Inspect and clean exhaust system.</li> </ul>

## Before you call for service...



<i>Problem</i>	<i>Possible Causes</i>	<i>What To Do</i>
<i>Small amount of water on floor in front of dryer</i>	Inadequate load size for steam cycle selected, excess steam condenses inside cabinet and leaks out	<ul style="list-style-type: none"> <li>If using the <b>Steam Dewrinkle</b> cycle, manually reduce time. If using the <b>Steam Refresh</b> cycle, add more</li> </ul>
<i>Water on floor in back of dryer</i>	Loose water hose connection to valve	<ul style="list-style-type: none"> <li>Install rubber washer provided with hose.</li> </ul>
	Hose missing rubber washer at connection with valve	
<i>Water drips from door when opened after a Steam Cycle</i>	Steam condenses on inner door	<ul style="list-style-type: none"> <li>This is normal.</li> </ul>
<i>Cannot see steam at beginning of cycle</i>	Steam released at different time in cycle	<ul style="list-style-type: none"> <li>This is normal.</li> </ul>
<i>Cannot see steam at any time during the cycle</i>	The steam nozzle might be clogged with debris from your water supply	<ul style="list-style-type: none"> <li>Call <b>800.GE.CARES</b> to order nozzle replacement kit <b>WE25M71</b> or to request a service technician to replace this for you.</li> </ul>
<i>Garments still wrinkled after steam cycle</i>	Too many garments	<ul style="list-style-type: none"> <li>Load fewer garments; manually increase time</li> </ul>
<i>Dryer continues to tumble after display says complete</i>	Extended/Dewrinkle Tumble was selected	<ul style="list-style-type: none"> <li>Ensure <b>Extended/Dewrinkle Tumble</b> option is not selected. For the <b>Steam Refresh</b> cycle, <b>Extended/Dewrinkle Tumble</b> will automatically be turned on and cannot be turned off</li> </ul>
<i>Garments are wet after Steam cycle</i>	Lint filter not clean	<ul style="list-style-type: none"> <li>Clean lint filter</li> </ul>
	Load is children/infant garments	<ul style="list-style-type: none"> <li>Use the <b>Steam Refresh</b> cycle.</li> </ul>
<i>No numbers displayed during cycle, only lights</i>	Dryer is continuously monitoring the amount of moisture in the clothes	<ul style="list-style-type: none"> <li>This is normal. When the dryer senses a low level of moisture in the load, the dryer will display the dry time remaining.</li> </ul>
<i>Time Remaining jumped to a lower number</i>	The estimated time may change when a smaller load than usual is drying	<ul style="list-style-type: none"> <li>This is normal.</li> </ul>
<i>Dryer is running but 00 is displayed in Time Remaining</i>	The Extended/Dewrinkle Tumble option was chosen	<ul style="list-style-type: none"> <li>This is normal. During <b>Extended/Dewrinkle Tumble</b>, the time remaining is not displayed. The extended tumbling option lasts approximately 60 minutes; dewrinkle 60 minutes</li> </ul>
<i>Clothes are still wet and dryer shuts off after a short time</i>	The door was opened mid-cycle. The load was then removed from the dryer and a new load put in without selecting a new cycle	<ul style="list-style-type: none"> <li>A dry cycle must be re-selected each time a new load is put in.</li> </ul>
	Small load	<ul style="list-style-type: none"> <li>When drying 3 items or less, choose <b>Speed Dry</b> or <b>Timed Dry</b>.</li> </ul>
	Load was already dry except for collars and waistbands	<ul style="list-style-type: none"> <li>Choose <b>Speed Dry</b> or <b>Timed Dry</b> to dry damp collars and waistbands. In the future, when drying a load with collars and waistbands, choose <b>More Dry</b>.</li> </ul>
	Dryer is not level	<ul style="list-style-type: none"> <li>Move dryer to an even floor space or adjust leveling legs as necessary until even.</li> </ul>

## Before you call for service...



<b>Problem</b>	<b>Possible Causes</b>	<b>What To Do</b>
<i>Small amount of water on floor in front of dryer</i>	Inadequate load size for steam cycle selected, excess steam condenses inside cabinet and leaks out	<ul style="list-style-type: none"> <li>If using the <b>Steam Dewrinkle</b> cycle, manually reduce time. If using the <b>Steam Refresh</b> cycle, add more</li> </ul>
<i>Water on floor in back of dryer</i>	Loose water hose connection to valve	<ul style="list-style-type: none"> <li>Install rubber washer provided with hose.</li> </ul>
	Hose missing rubber washer at connection with valve	
<i>Water drips from door when opened after a Steam Cycle</i>	Steam condenses on inner door	<ul style="list-style-type: none"> <li>This is normal.</li> </ul>
<i>Cannot see steam at beginning of cycle</i>	Steam released at different time in cycle	<ul style="list-style-type: none"> <li>This is normal.</li> </ul>
<i>Cannot see steam at any time during the cycle</i>	The steam nozzle might be clogged with debris from your water supply	<ul style="list-style-type: none"> <li>Call <b>800.GE.CARES</b> to order nozzle replacement kit <b>WE25M71</b> or to request a service technician to replace this for you.</li> </ul>
<i>Garments still wrinkled after steam cycle</i>	Too many garments	<ul style="list-style-type: none"> <li>Load fewer garments; manually increase time</li> </ul>
<i>Dryer continues to tumble after display says complete</i>	Extended/Dewrinkle Tumble was selected	<ul style="list-style-type: none"> <li>Ensure <b>Extended/Dewrinkle Tumble</b> option is not selected. For the <b>Steam Refresh</b> cycle, <b>Extended/Dewrinkle Tumble</b> will automatically be turned on and cannot be turned off</li> </ul>
<i>Garments are wet after Steam cycle</i>	Lint filter not clean	<ul style="list-style-type: none"> <li>Clean lint filter</li> </ul>
	Load is children/infant garments	<ul style="list-style-type: none"> <li>Use the <b>Steam Refresh</b> cycle.</li> </ul>
<i>No numbers displayed during cycle, only lights</i>	Dryer is continuously monitoring the amount of moisture in the clothes	<ul style="list-style-type: none"> <li>This is normal. When the dryer senses a low level of moisture in the load, the dryer will display the dry time remaining.</li> </ul>
<i>Time Remaining jumped to a lower number</i>	The estimated time may change when a smaller load than usual is drying	<ul style="list-style-type: none"> <li>This is normal.</li> </ul>
<i>Dryer is running but 00 is displayed in Time Remaining</i>	The Extended/Dewrinkle Tumble option was chosen	<ul style="list-style-type: none"> <li>This is normal. During <b>Extended/Dewrinkle Tumble</b>, the time remaining is not displayed. The extended tumbling option lasts approximately 60 minutes; dewrinkle 60 minutes</li> </ul>
<i>Clothes are still wet and dryer shuts off after a short time</i>	The door was opened mid-cycle. The load was then removed from the dryer and a new load put in without selecting a new cycle	<ul style="list-style-type: none"> <li>A dry cycle must be re-selected each time a new load is put in.</li> </ul>
	Small load	<ul style="list-style-type: none"> <li>When drying 3 items or less, choose <b>Speed Dry</b> or <b>Timed Dry</b>.</li> </ul>
	Load was already dry except for collars and waistbands	<ul style="list-style-type: none"> <li>Choose <b>Speed Dry</b> or <b>Timed Dry</b> to dry damp collars and waistbands. In the future, when drying a load with collars and waistbands, choose <b>More Dry</b>.</li> </ul>
	Dryer is not level	<ul style="list-style-type: none"> <li>Move dryer to an even floor space or adjust leveling legs as necessary until even.</li> </ul>

# GE Dryer Warranty.



All warranty support provided by our authorized service centers. To schedule service, on-line, 24 hours a day, visit us at [GEAppliances.ca](http://GEAppliances.ca) or call **800.561.3344** during normal business hours. Please have serial number and model number available when calling for service.

*Staple your receipt here.  
Proof of the original purchase date is needed to obtain support under the warranty.*

## For The Period Of: GE Will Replace:

### One Year

*From the date of the original purchase*

**Any part** of the dryer which fails due to a defect in materials or workmanship. During this **limited one-year warranty**, GE will also provide, **free of charge**, all labor and related service costs to replace the defective part.

## What GE Will Not Cover:

- Service trips to your home to teach you how to use the product.
- Improper installation, delivery or maintenance.
- Failure of the product if it is abused, misused, or used for other than the intended purpose or used commercially.
- Replacement of the light bulb.
- Replacement of house fuses or resetting of circuit breakers.
- Damage to the product caused by accident, fire, floods or acts of God.
- Incidental or consequential damage caused by possible defects with this appliance.
- Damage caused after delivery.
- Product not accessible to provide required service.
- Defects or damage due to operation in freezing temperatures.
- Products which are not defective or broken, or which are working as described in the Owner's Manual.

**EXCLUSION OF IMPLIED WARRANTIES—Your sole and exclusive remedy is product repair as provided in this Limited Warranty. Any implied warranties, including the implied warranties of merchantability or fitness for a particular purpose, are limited to one year or the shortest period allowed by law.**

*This warranty is extended to the original purchaser and any succeeding owner for products purchased in Canada for home use within Canada. In-home warranty service will be provided in areas where it is available and deemed reasonable by MC Commercial to provide.*

Warrantor: MC Commercial, Burlington, L7R 5B6

# Consumer Support.

---



## GE Appliances Website

**GEAppliances.ca**

Have a question or need assistance with your appliance? Try the GE Appliances Website 24 hours a day, any day of the year! For greater convenience and faster service, you can now download Owner's Manuals, order parts or even schedule service on-line.



## Schedule Service

**GEAppliances.ca**

Expert GE repair service is only one step away from your door. Get on-line and schedule your service at your convenience 24 hours any day of the year! Or call **800.561.3344** during normal business hours.



## Real Life Design Studio

**GEAppliances.ca**

GE supports the Universal Design concept—products, services and environments that can be used by people of all ages, sizes and capabilities. We recognize the need to design for a wide range of physical and mental abilities and impairments. For details of GE's Universal Design applications, including kitchen design ideas for people with disabilities, check out our Website today. Call **800.561.3344**.



## Extended Warranties

Consult your local listings for the nearest extended warranty provider.

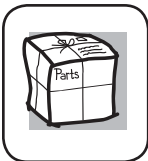

## Parts and Accessories

**GEAppliances.ca**

Individuals qualified to service their own appliances can have parts or accessories sent directly to their homes. Visit your local authorized GE parts distributor or call **800.661.1616**.

Instructions contained in this manual cover procedures to be performed by any user. Other servicing generally should be referred to qualified service personnel. Caution must be exercised, since improper servicing may cause unsafe operation.



## Contact Us

**GEAppliances.ca**

If you are not satisfied with the service you receive from GE, contact us on our Website with all the details including your phone number, or write to:  
Director, Consumer Relations, MC Commercial  
Suite 310, 1 Factory Lane  
Moncton, N.B. E1C 9M3



## Register Your Appliance

**GEAppliances.ca**

**Register your new appliance on-line—at your convenience!** Timely product registration will allow for enhanced communication and prompt service under the terms of your warranty, should the need arise. You may also mail in the pre-printed registration card included in the packing material.