



Top-Freezer REFRIGERATORS

SAFETY INFORMATION3

USING THE REFRIGERATOR

Temperature Control5

Garage Operation.....5

Sabbath Mode.....5

Fresh Food Compartment Shelves6

Freezer Compartment Shelves6

Storage Drawers.....7

Automatic Ice Maker8

CARE AND CLEANING9

INSTALLATION INSTRUCTIONS

Preparing to Install the Refrigerator.....10

Water Line Installation 11

Installing the Door Handle14

Reversing the Door Swing15

TROUBLESHOOTING

Normal Operating Sounds 20

LIMITED WARRANTY 21

CONSUMER SUPPORT22

OWNER'S MANUAL & INSTALLATION INSTRUCTIONS

Models 16, 17, 18, 19, 22

**ENGLISH/FRANÇAIS/
ESPAÑOL**

Write the model and serial numbers here:

Model # _____

Serial # _____

Find these numbers on a label on the left side, near the middle of the refrigerator compartment.

THANK YOU FOR MAKING GE APPLIANCES A PART OF YOUR HOME.

Whether you grew up with GE Appliances, or this is your first, we're happy to have you in the family.

We take pride in the craftsmanship, innovation and design that goes into every GE Appliances product, and we think you will too. Among other things, registration of your appliance ensures that we can deliver important product information and warranty details when you need them.

Register your GE appliance now online. Helpful websites and phone numbers are available in the Consumer Support section of this Owner's Manual. You may also mail in the pre-printed registration card included in the packing material.



IMPORTANT SAFETY INFORMATION

READ ALL INSTRUCTIONS BEFORE USING THE APPLIANCE

▲ WARNING To reduce the risk of fire, explosion, electric shock, or injury when using your refrigerator, follow these basic safety precautions:

- This refrigerator must be properly installed and located in accordance with the Installation Instructions before it is used.
- Unplug the refrigerator before making repairs or cleaning.

NOTE: Power to the refrigerator cannot be disconnected by any setting on the control panel.

NOTE: Repairs must be performed by a qualified Service Professional.
- Replace all parts and panels before operating.
- Do not use an extension cord.
- Keep flammable materials and vapors away from the refrigerator.
- Do not store explosive substances such as aerosol cans with a flammable propellant in this appliance.
- To prevent suffocation and entrapment hazards to children, remove the fresh food and freezer doors from any refrigerator before disposing of it or discontinuing its use.
- To avoid serious injury or death, children should not stand on, or play in or with the appliance.
- Children and persons with reduced physical, sensory or mental capabilities or lack of experience and knowledge can use this appliance only if they are supervised or have been given instructions on safe use and understand the hazards involved.
- This appliance is intended to be used in household and similar applications such as: staff kitchen areas in shops, offices and other working environments; farm houses; by clients in hotels, motels, bed & breakfast and other residential environments; catering and similar non-retail applications.
- Connect to potable water supply only. A cold water supply is required for automatic icemaker operation. The water pressure must be between 40 and 120 psi (275-827 kilopascals).
- Do not apply harsh cleaners to the refrigerator. Certain cleaners will damage plastic which may cause parts such as the door or door handles to detach unexpectedly. See the Care and Cleaning section for detailed instructions.

▲ CAUTION To reduce the risk of injury when using your refrigerator, follow these basic safety precautions.

- Do not clean glass shelves or covers with warm water when they are cold. Glass shelves and covers may break if exposed to sudden temperature changes or impact, such as bumping or dropping. Tempered glass is designed to shatter into many small pieces if it breaks.
- Keep fingers out of the “pinch point” areas; clearances between the doors and between the doors and cabinet are necessarily small. Be careful closing doors when children are in the area.
- Do not touch the cold surfaces in the freezer compartment when hands are damp or wet, skin may stick to these extremely cold surfaces.
- Do not refreeze frozen foods which have thawed completely.
- In refrigerators with automatic ice makers, avoid contact with the moving parts of the ejector mechanism, or with the heating element that releases the cubes. Do not place fingers or hands on the automatic ice making mechanism while the refrigerator is plugged in.

▲ WARNING  **FIRE OR EXPLOSION HAZARD Flammable Refrigerant**

This appliance contains isobutane refrigerant, also known as R600a, a natural gas with high environmental compatibility. However, it is also combustible. Adhere to the warnings below to reduce the risk of injury or property damage.

1. When handling, installing and operating the appliance, care should be taken to avoid damage to the refrigerant tubing.
2. Service shall only be performed by authorized service personnel. Use only manufacturer-authorized service parts.
3. Dispose of refrigerator in accordance with the Federal and Local Regulations. The flammable refrigerant and insulation material used in this product require special disposal procedures. Contact your local authorities for the environmentally safe disposal of your refrigerator.
4. Keep ventilation openings in the appliance enclosures or in the built-in structure clear of obstruction.
5. To remove frost, scrape with a plastic or wood spatula or scraper. Do not use an ice pick or a metal or sharp-edged instrument as it may puncture the freezer liner and then the flammable refrigerant tubing behind it.
6. Do not use electrical appliances inside the food storage compartment of the appliance.
7. Do not use any electrical device to defrost your freezer.

READ AND SAVE THESE INSTRUCTIONS

IMPORTANT SAFETY INFORMATION

READ ALL INSTRUCTIONS BEFORE USING THE APPLIANCE

INSTALLATION

▲ WARNING FIRE OR EXPLOSION HAZARD

Keep flammable materials and vapors away from refrigerator. Failure to do so can result in fire, explosion, or death.

CONNECTING ELECTRICITY

▲ WARNING ELECTRICAL SHOCK HAZARD

Plug into a grounded 3-prong outlet
 Do not remove the ground prong
 Do not use an adapter
 Do not use an extension cord.
 Failure to follow these instructions can result in death, fire, or electrical shock.

Do not, under any circumstances, cut or remove the third (ground) prong from the power cord. For personal safety, this appliance must be properly grounded.

The power cord of this appliance is equipped with a 3-prong (grounding) plug which mates with a standard 3-prong (grounding) wall outlet to minimize the possibility of electric shock hazard from this appliance.

Have the wall outlet and circuit checked by a qualified electrician to make sure the outlet is properly grounded.

Where a standard 2-prong wall outlet is encountered, it is your personal responsibility and obligation to have it replaced with a properly grounded 3-prong wall outlet. Do not use an adapter.

The refrigerator should always be plugged into its own individual electrical outlet which has a voltage rating that matches the rating plate.

A 115 Volt AC, 60 Hz, 15- or 20-amp fused, grounded electrical supply is required. This provides the best performance and also prevents overloading house wiring circuits which could cause a fire hazard from overheated wires.

Never unplug your refrigerator by pulling on the power cord. Always grip plug firmly and pull straight out from the outlet.

Immediately discontinue use of a damaged supply cord. If the supply cord is damaged, it must be replaced by a qualified service professional with an authorized service part from the manufacturer.

When moving the refrigerator away from the wall, be careful not to roll over or damage the power cord.

PROPER DISPOSAL OF YOUR OLD REFRIGERATOR

▲ WARNING SUFFOCATION AND ENTRAPMENT HAZARD

Failure to follow these disposal instructions can result in death or serious injury

IMPORTANT: Child entrapment and suffocation are not problems of the past. Junked or abandoned refrigerators are still dangerous even if they will sit for “just a few days.” If you are getting rid of your old refrigerator, please follow the instructions below to help prevent accidents.

Before You Throw Away Your Old Appliance

- Take off the fresh food and freezer doors.
- Leave the shelves in place so that children may not easily climb inside.

Refrigerant and Foam Disposal:

Dispose of appliance in accordance with Federal and Local Regulations. Flammable refrigerant and insulation material used requires special disposal procedures. Contact your local authorities for the environmentally safe disposal of your appliance.

READ AND SAVE THESE INSTRUCTIONS

Temperature Control for locations between 55°F-110°F

The temperature control adjusts the refrigerator from its warmest to coldest settings.

Your refrigerator will come with the recommended factory setting on “3”. For colder temperature, turn the knob clockwise to either setting “4” or “5”. For warmer temperature, turn the dial counter-clockwise to either setting “1” or “2”. To turn off the cooling in both compartments, turn the knob counter-clockwise to setting “Off”. Note that this does not shut off power to the refrigerator.

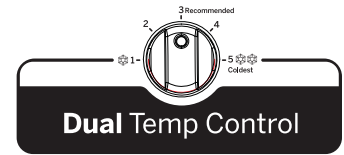
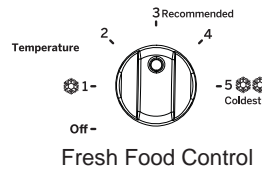

Freezer Control
Models with dual temperature control only.

Garage Operation for locations between 38°F-54°F

Models with dual temperature control have an adjustable freezer control and can be operated in locations with ambient temperatures between 38-110°F (3.3-43.3°C). For cold ambient conditions 38-54°F (3.3-12.2°C) the fresh food should be set to setting 2 to prevent food from freezing in the fresh food compartment, and the freezer setting should be adjusted to position 5 to prevent food from thawing in the freezer compartment.

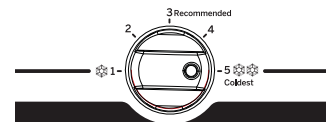
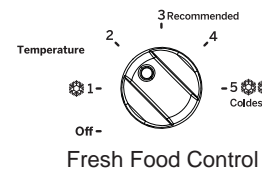

Freezer Control
Cold Ambient Setting

Sabbath Mode OU (Orthodox Union) and CRC (Central Rabbinical Congress)

This refrigerator offers an OU and CRC Sabbath mode that complies with standards set forth by Orthodox Union, the Central Rabbinical Congress, and Halacha Tech, and is 100% certified to the highest halacha standards. Sabbath mode requires that the control knob and light switch are operated at the same time. The light switch is located just to the left of the control knob.

To enter Sabbath Mode, turn the control knob to position 5, then hold down the light switch. While the light switch is held down, turn the control knob to position 3. Once the control knob is in position 3, release the light switch. When you release the light switch, the light will dim and product is in Sabbath mode.

To exit Sabbath mode, turn the control knob to **OFF**. After 5 secs, then turn the knob to the setting (1 through 5) used prior to entering Sabbath mode. If Sabbath mode is not exited manually, it will end automatically after 96 hours. If power is disconnected from the product while it is in Sabbath mode, it will remain in Sabbath mode after power is reconnected. Sabbath mode does not deactivate the icemaker, if present. The icemaker must be turned off manually by moving the icemaker switch to the off position. The icemaker switch is located on the icemaker in the freezer compartment.

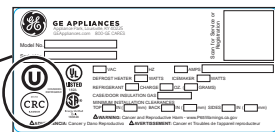
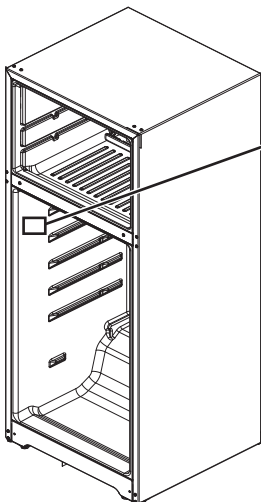

Please check your rating label to confirm whether your unit offers the OU and CRC Sabbath mode. Only units with the OU and CRC logo on the rating label comply with the standards set forth by Orthodox Union, the Central Rabbinical Congress, and Halacha Tech.



Fresh Food Compartment Shelves

Shelf supports at various levels allow you to custom-space your shelves. Not all features are on all models.

Full-Width Shelves

Some models have a stationary tempered glass shelf or two steel wire stationary shelves. These shelves can be moved to another place in the fresh food compartment. When placed correctly on the shelf supports, the shelf will stop before coming completely out of the refrigerator and will not tilt when you place food on it or remove food from it.

Pull glass shelves forward so the glass rests evenly on side rails. For units with glass shelves, rail positions 2 and 4/5 are recommended.

CAUTION Do not clean glass shelves or covers with warm water when they are cold. Glass shelves and covers may break if exposed to sudden temperature changes or impact such as bumping or dropping. Tempered glass is designed to shatter into many small pieces if it breaks.

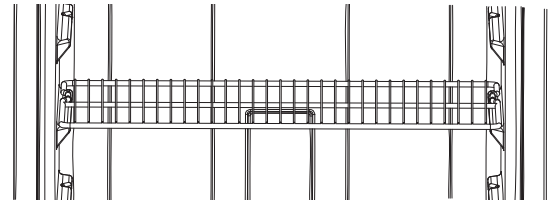

Wire shelf - lift back end and pull forward to remove

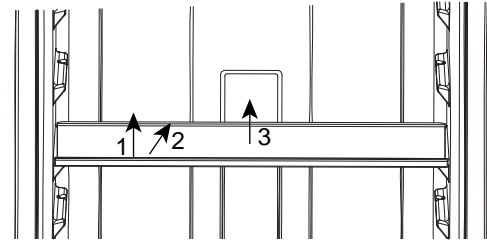

Glass shelf - lift the front edge (1), push shelf back (2), lift shelf up and pull forward (3) to remove.

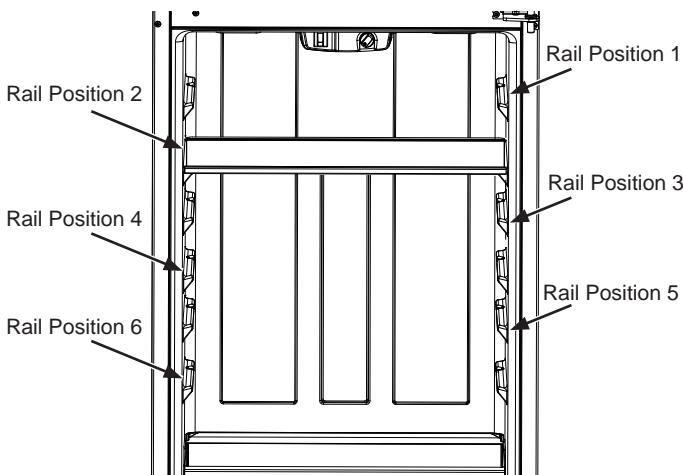

Freezer Compartment Shelves

When placed correctly on the shelf supports, the steel wire stationary shelves will stop before coming completely out of the freezer and will not tilt when you place food on it or remove food from it.

Some models have glass shelves.

To ensure shelf functions as intended, slide shelf to the furthest back retention point:

- Glass Shelf - front slot 1
- Steel Wire Shelf - rear slot 2

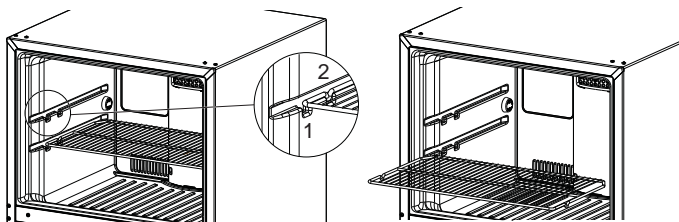

CAUTION Do not clean glass shelves or covers with warm water when they are cold. Glass shelves and covers may break if exposed to sudden temperature changes or impact such as bumping or dropping. Tempered glass is designed to shatter into many small pieces if it breaks.

Storage Drawers

Not all features are on all models.

Snack Drawer

The snack drawer can be moved to the most useful location for your family's needs.

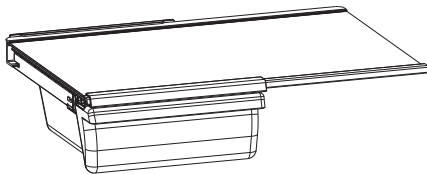

Fruit and Vegetable Drawers

Excess water that may accumulate in the bottom of the drawers should be emptied and the drawers wiped dry.

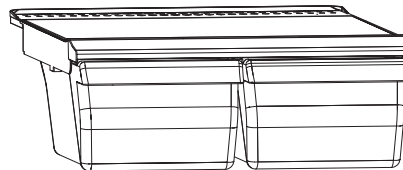

Drawer and Cover

Drawer Removal

Drawers can be removed easily by grasping the sides and lifting up slightly while pulling drawers past the stop location.

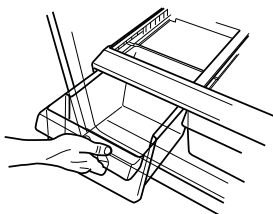

Cover Removal

1. Remove the drawers.

2. Reach in, push the back of glass cover up, and at the same time, pull it backward as far as it will come.

Tilt it and take it out. Avoid cleaning the cold glass cover with hot water because the extreme temperature difference may cause it to break.

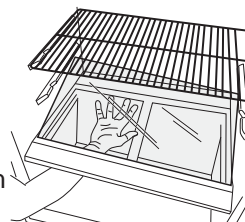

3. Remove the drawer frame. (Always remove the glass cover before you take out the drawer frame.)

Lift the frame off the supports at each side and back, pull it forward, tilt it and take it out.

To replace:

1. Lower the frame until it rests on the supports at each side and back.

2. Replace the glass cover, pushing its front edge firmly into the front frame channel and gently lowering the back into place.

3. Replace the drawers.

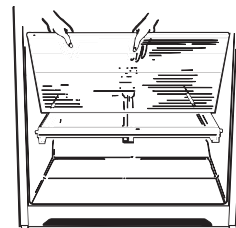

Automatic Icemaker (on some models)

Not all features are on all models.

⚠ WARNING Connect to potable water supply only. A cold water supply is required for automatic icemaker operation. The water pressure must be between 40 and 120 psi (275-827 kilopascals).

⚠ CAUTION Avoid contact with the moving parts of the ejector mechanism, or with the heating element (located on the bottom of the ice maker) that releases the cubes. Do not place fingers or hands on the automatic ice making mechanism while the refrigerator is plugged in.

A newly-installed refrigerator may take 12–24 hours to begin making ice.

The ice maker will produce approximately 70-100 cubes in a 24-hour period, depending on the freezer compartment temperature, room temperature, number of door openings and other use conditions.

If the refrigerator is operated before the water connection is made to the ice maker, set the switch OFF.

When the refrigerator has been connected to the water supply, set the switch ON position.

The ice maker will fill with water when it cools to 15°F (-9°C). A newly-installed refrigerator may take 12 to 24 hours to begin making ice cubes.

Once the ice maker starts to make ice, it may take up to 48 hours to fill the bin, depending on the temperature settings and number of door openings.

You will hear a buzzing sound each time the ice maker fills with water.

NOTICE: Throw away the first few batches of ice to allow the water line to clear.

Be sure nothing interferes with the sweep of the feeler arm.

When the bin fills to the level of the feeler arm, the ice maker will stop producing ice.

It is normal for several cubes to be joined together.

If ice is not used frequently, old ice cubes will become cloudy, taste stale, shrink or fuse together.

Ice maker accessory kit:

If your refrigerator did not already come equipped with an automatic ice maker, an ice maker accessory kit is available at extra cost.

This refrigerator will accept accessory icemaker kit IM-4D or IM-6D. Use instructions X supplied in the kit for assembly.

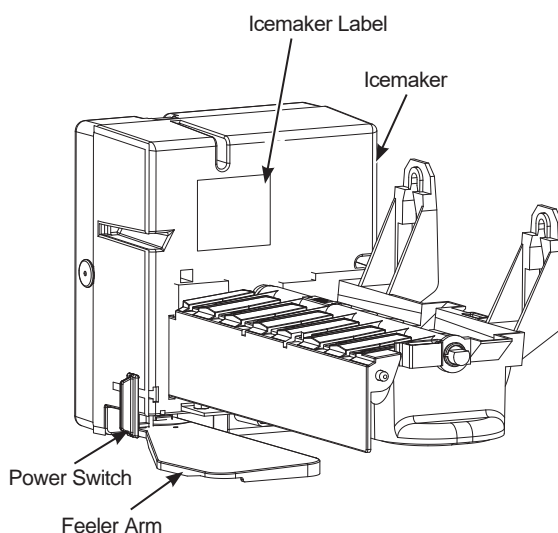

IMPORTANT: This refrigerator requires a red label icemaker. See above for the location of the label on the icemaker. If the icemaker that came with your kit does not have a red label, it will not function. In this case, please call 800.GE.CARES (in Canada 800.561.3344) for the correct icemaker.

Care And Cleaning

Cleaning the Outside

FINGERPRINT RESISTANT STAINLESS STEEL*, BLACK STAINLESS, SLATE, DARK SLATE, PAINTED - Outside surfaces, door handles, and trim

⚠ DO NOT use Stainless Steel cleaners on the door surfaces. ⚠

IMPORTANT: The use of incorrect products may damage the outer finish of Fingerprint Resistant Stainless models. Please follow these instructions and use only the appropriate items below to clean your appliance surfaces.

DO USE	DO NOT USE
<p><i>On all models:</i> Soft, clean cloth or sponge</p>	Abrasive cloths, scrubbing sponges, scouring or steel wool pads
<p><i>On fingerprint resistant* and painted models:</i> Mild detergent mixed with warm water</p>	<p>Abrasive powders, liquids, or sprays Window sprays, ammonia, or bleach Citrus or plant oil based cleaners Acidic or vinegar based cleaners</p> <p>Oven cleaners Alkaline cleaners Stainless steel cleaners</p>
<p><i>On stainless steel models:</i> Mild detergent mixed with warm water Approved stainless steel cleaners; Visit the GE Appliances parts store for approved stainless steel cleaners: GEAppliancesparts.com or call 877.959.8688 Cleaners with oxalic acid such as Bar Keepers Friend Soft Cleanser™ can be used to remove surface rust, tarnish and small blemishes on stainless steel surfaces only.</p>	<p>Abrasive powders or sprays Window Sprays or Ammonia Citrus or plant oil-based cleaners Acidic or vinegar-based cleaners Oven cleaners Cleaners containing acetone (propanone) Any cleaner with WARNING about plastic contact</p>

*Easily wipe away smudges and fingerprints.

NOTE: DO NOT allow stainless steel cleaner to come in contact with any plastic parts such as trim pieces, handle hardware and liners. If unintentional contact of cleaners with plastic parts does occur, clean plastic part with a sponge and mild detergent mixed with warm water.

Cleaning the Inside

To help prevent odors, leave an open box of baking soda in the fresh food and freezer compartments.

Unplug the refrigerator before cleaning. If this is not practical, wring excess moisture out of sponge or cloth when cleaning around switches, lights or controls.

Use warm water and baking soda solution—about a tablespoon (15 ml) of baking soda to a quart (1 liter) of water. This both cleans and neutralizes odors. Rinse and wipe dry.

After cleaning the door gaskets, apply a thin layer of petroleum jelly to the door gaskets at the hinge side. This helps keep the gaskets from sticking and bending out of shape.

⚠ CAUTION Do not clean glass shelves or covers with warm water when they are cold. Glass shelves and covers may break if exposed to sudden temperature changes or impact such as bumping or dropping. Tempered glass is designed to shatter into many small pieces if it breaks. Do not wash any plastic refrigerator parts in the dishwasher.

Moving the Refrigerator

Be careful when moving the refrigerator away from the wall. All types of floor coverings can be damaged, particularly cushioned coverings and those with embossed surfaces.

Turn the leveling legs at each front corner of the refrigerator counterclockwise until the rollers support the refrigerator. Pull the refrigerator straight out and return it to position by pushing it straight in. Moving the refrigerator in a side direction may result in damage to the floor covering or refrigerator.

When pushing the refrigerator back, make sure you don't roll over the power cord or ice maker supply line (on some models). After rolling the refrigerator back into place, turn the legs clockwise until the legs again bear the weight of the refrigerator.

Replacing the Lights

LED lighting is located at the top center of the fresh food compartment.

An authorized technician will need to replace the LED light.

If this assembly needs to be replaced, call GE Appliances Service at 1.800.432.2737 in the United States or 1.800.561.3344 in Canada.

Preparing for Vacation

For long vacations or absences, remove food and unplug the refrigerator. Move the temperature control dial to the OFF position, and clean the interior with a baking soda solution of one tablespoon (15 ml) of baking soda to one quart (1 liter) of water. Leave the doors open.

Move the switch to the OFF position on the power switch model, and shut off the water supply to the refrigerator.

If the temperature can drop below freezing, have a qualified servicer drain the water supply system (on some models) to prevent serious property damage due to flooding.

Preparing to Move

Secure all loose items such as grille, shelves and drawers by taping them securely in place to prevent damage. To prevent the doors from opening while moving, secure them to the case with tape. Be sure the refrigerator stays in an upright position during moving.