



Radiant COOKTOP

SAFETY INFORMATION 3

USING THE COOKTOP

Cooktop Features..... 5

Radiant Glass Cooktop12

Home Canning Tips12

Cookware for Radiant Glass Cooktop.....13

Element Cycling14

Turn Product On/Off.....14

Operating The Cooking Elements14

How To Synchronize Left Elements 15

Selecting Cooktop Settings15

Cooktop Lockout16

Hot Light Indicator.....16

Griddle (optional accessory)17

CARE AND CLEANING

Cleaning the Glass Cooktop.....18

TROUBLESHOOTING TIPS..... 20

LIMITED WARRANTY 22

ACCESSORIES 23

CONSUMER SUPPORT 24

OWNER'S MANUAL

- JP3030 JEP5030
- JP3036 JEP5036
- JP3530
- JP3536
- PP7030
- PP7036
- CP9530
- CP9536

ENGLISH/FRANÇAIS/ESPAÑOL

Write the model and serial numbers here:

Model # _____

Serial # _____

You can find them on a label under the cooktop.

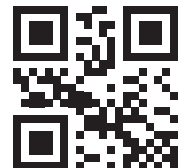

THANK YOU FOR MAKING GE APPLIANCES A PART OF YOUR HOME.

Whether you grew up with GE Appliances, or this is your first, we're happy to have you in the family.

We take pride in the craftsmanship, innovation and design that goes into every GE Appliances product, and we think you will too. Among other things, registration of your appliance ensures that we can deliver important product information and warranty details when you need them.

Register your GE appliance now online. Helpful websites and phone numbers are available in the Consumer Support section of this Owner's Manual. You may also mail in the pre-printed registration card included in the packing material.



IMPORTANT SAFETY INFORMATION

READ ALL INSTRUCTIONS BEFORE USING THE APPLIANCE

▲WARNING Read all safety instructions before using the product. Failure to follow these instructions may result in fire, electrical shock, serious injury or death.

▲WARNING GENERAL SAFETY INSTRUCTIONS

- Use this cooktop only for its intended purpose as described in this Owner's Manual.
- Be sure your cooktop is properly installed and grounded by a qualified installer in accordance with the provided installation instructions.
- Do not attempt to repair or replace any part of your cooktop unless it is specifically recommended in this manual. All other servicing should be performed by a qualified technician.
- Before performing any service, unplug the cooktop or disconnect the power supply at the household distribution panel by removing the fuse or switching off the circuit breaker.
- Do not leave children alone—children should not be left alone or unattended in an area where the cooktop is in use. They should never be allowed to climb, sit or stand on any part of the cooktop.
- **▲CAUTION** Do not store items of interest to children above the cooktop—children climbing on the cooktop to reach items could be seriously injured.
- Use only dry pot holders—moist or damp pot holders on hot surfaces may result in burns from steam. Do not let pot holders touch hot surface units or heating elements. Do not use a towel or other bulky cloth in place of pot holders.
- Never use your cooktop for warming or heating the room.
- Do not touch surface elements. These surfaces may be hot enough to burn even though they are dark in color. During and after use, do not touch, or let clothing or other flammable materials contact the surface elements or areas nearby the surface elements; allow sufficient time for cooling first.
- Potentially hot surfaces include the cooktop and areas facing the cooktop.
- Do not heat unopened food containers. Pressure could build up and the container could burst, causing an injury.
- Cook meat and poultry thoroughly—meat to at least an internal temperature of 160°F and poultry to at least an internal temperature of 180°F. Cooking to these temperatures usually protects against foodborne illness.

▲WARNING KEEP FLAMMABLE MATERIALS AWAY FROM THE COOKTOP

Failure to do so may result in fire or personal injury.

- Do not store or use flammable materials near the cooktop, including paper, plastic, pot holders, linens, wall coverings, curtains, drapes and gasoline or other flammable vapors and liquids.
- Never wear loose-fitting or hanging garments while using the cooktop. These garments may ignite if they contact hot surfaces causing severe burns.
- Do not let cooking grease or other flammable materials accumulate in or near the cooktop. Grease on the cooktop may ignite.

PROPER DISPOSAL OF YOUR APPLIANCE

Dispose of or recycle your appliance in accordance with Federal and Local Regulations. Contact your local authorities for the environmentally safe disposal or recycling of your appliance.

READ AND SAVE THESE INSTRUCTIONS

IMPORTANT SAFETY INFORMATION

READ ALL INSTRUCTIONS BEFORE USING THE APPLIANCE

▲WARNING COOKTOP SAFETY INSTRUCTIONS

- In the event of a fire, do not use water or grease on fires. Never pick up a flaming pan. Turn the controls off. Smother a flaming pan on a surface unit by covering the pan completely with a well-fitted lid, cookie sheet or flat tray. Use a multi-purpose dry chemical or a foam-type fire extinguisher.
- Never leave the surface units unattended at medium or high heat settings. Boilovers cause smoking and greasy spillovers that may catch on fire.
- Never leave oil unattended while frying. If allowed to heat beyond its smoking point, oil may ignite resulting in fire that may spread to surrounding cabinets. Use a deep fat thermometer whenever possible to monitor oil temperature.
- To avoid spillover and fire, use a minimum amount of oil when shallow pan-frying and avoid cooking frozen foods with excessive amounts of ice.
- Use the proper pan size - select cookware having flat bottoms large enough to cover the surface heating element. The use of undersized cookware will expose a portion of the surface unit to direct contact and may result in ignition of clothing. Proper relationship of cookware to surface unit will also improve efficiency.
- To minimize the possibility of burns, ignition of flammable materials and spillage, the handle of a container should be turned toward the center of the range without extending over nearby surface units.
- If power is lost to an electric cooktop while a surface unit is ON, the surface unit will turn back on as soon as power is restored. In the event of a power loss, failure to turn all surface unit knobs to the OFF position may result in ignition of items on or near the cooktop, leading to serious injury or death.

▲WARNING RADIANT COOKTOP SAFETY INSTRUCTIONS

- Only certain types of glass, glass/ceramic, earthenware or other glazed containers are suitable for cooktop service; others may break because of the sudden change in temperature.
- Use care when touching the cooktop. The glass surface of the cooktop will retain heat after the controls have been turned off.
- Do not cook on a broken cooktop. If the glass cooktop should break, cleaning solutions and spillovers may penetrate the broken cooktop and create a risk of electric shock. Contact a qualified technician immediately.
- Avoid scratching the glass cooktop. The cooktop can be scratched with items such as knives, sharp instruments, rings or other jewelry, and rivets on clothing.
- Do not place or store items that can melt or catch fire on the glass cooktop, even when it is not being used. If the cooktop is inadvertently turned on, they may ignite. Heat from the cooktop or oven vent after it is turned off may cause them to ignite also.
- Use ceramic cooktop cleaner and non-scratch cleaning pad to clean the cooktop. Wait until the cooktop cools and the indicator light goes out before cleaning. A wet sponge or cloth on a hot surface can cause steam burns. Some cleaners can produce noxious fumes if applied to a hot surface. Read and follow all instructions and warnings on the cleaning cream label. **NOTE:** Sugary spills are an exception. They should be scraped off while still hot using an oven mitt and a scraper. See the Cleaning the glass cooktop section for detailed instructions.
- Do not place metallic objects such as knives, forks, spoons, and lids on the cooktop surface as they can get hot.

How to Remove Protective Shipping Film and Packaging Tape

Carefully grasp a corner of the protective shipping film with your fingers and slowly peel it from the appliance surface. Do not use any sharp items to remove the film. Remove all of the film before using the appliance for the first time.

To assure no damage is done to the finish of the product, the safest way to remove the adhesive from

packaging tape on new appliances is an application of a household liquid dishwashing detergent. Apply with a soft cloth and allow to soak.

NOTE: The adhesive must be removed from all parts. It cannot be removed if it is baked on.

Consider recycling options for your appliance packaging material.

READ AND SAVE THESE INSTRUCTIONS

Cooktop Features

Throughout this manual, features and appearance may vary from your model.

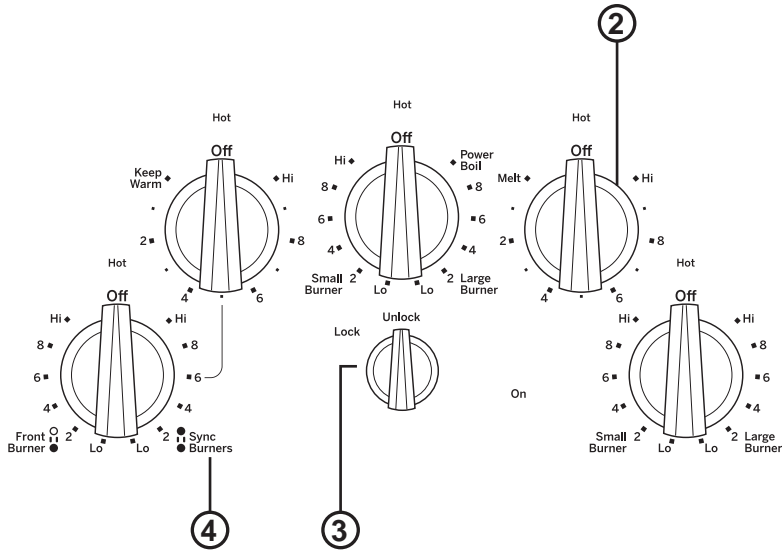
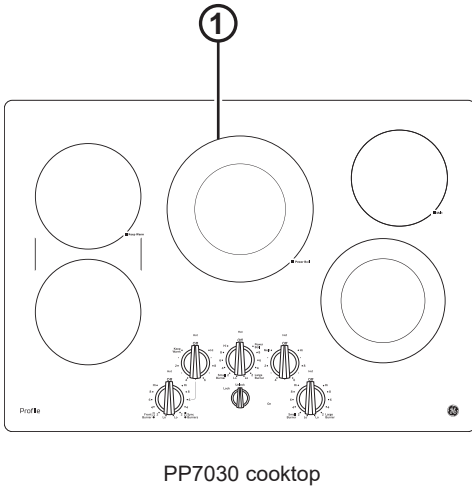
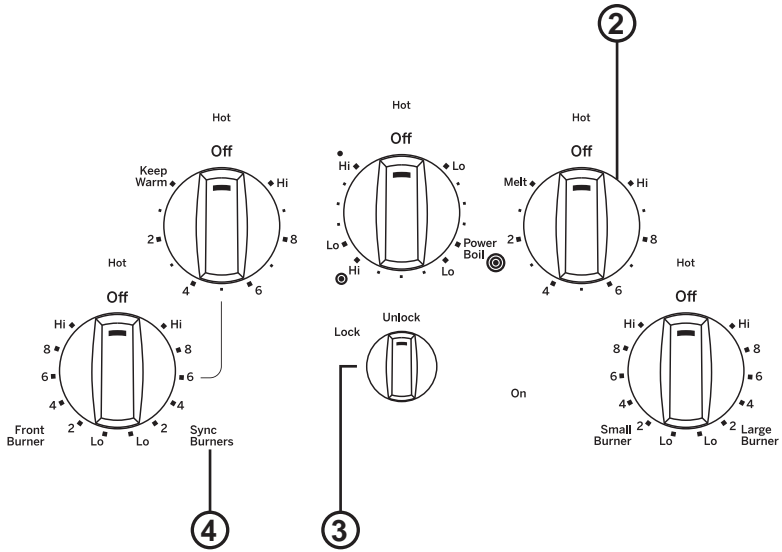
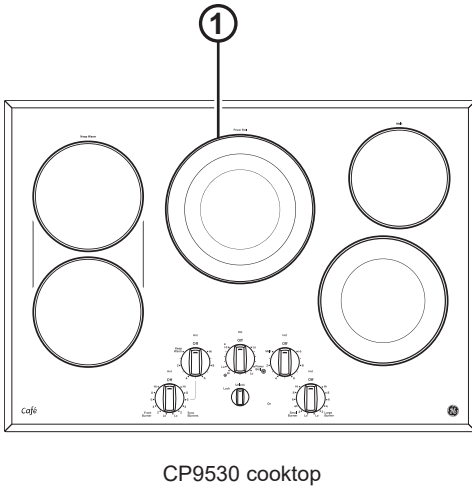

- 1. **Cooking Element(s):** See page 14.
- 2. **Control Knob(s):** See page 14.
- 3. **Lock:** See page 16.
- 4. **Sync Burners:** See page 15.

Cooktop Features

Throughout this manual, features and appearance may vary from your model.

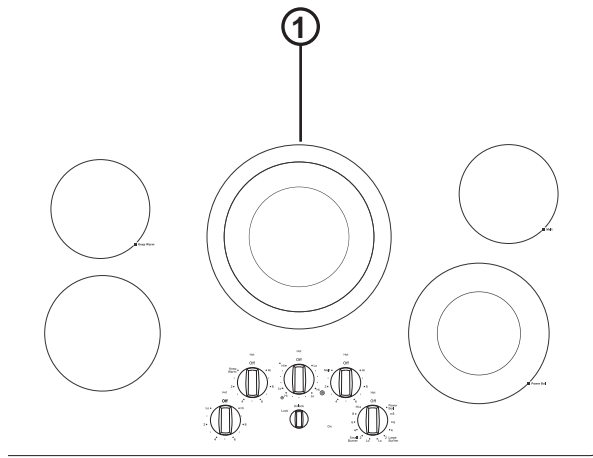

CP9530 cooktop

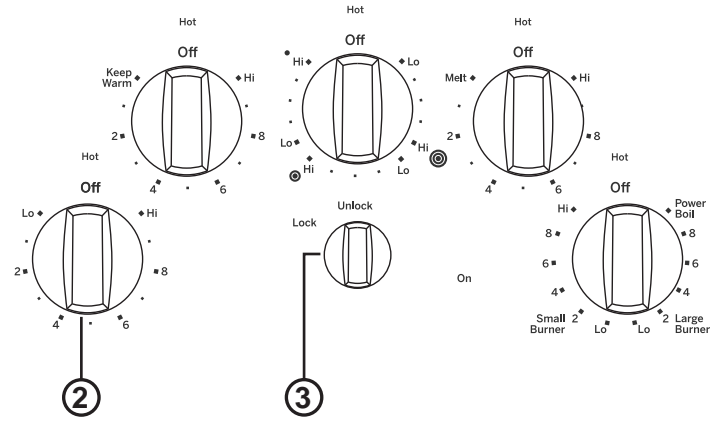

User Interface Controls

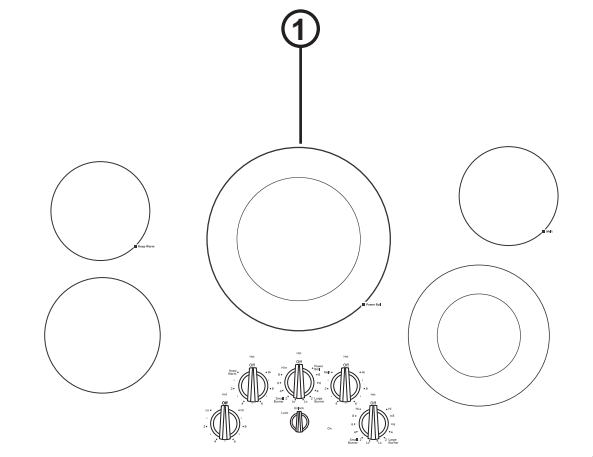

CP9530 cooktop

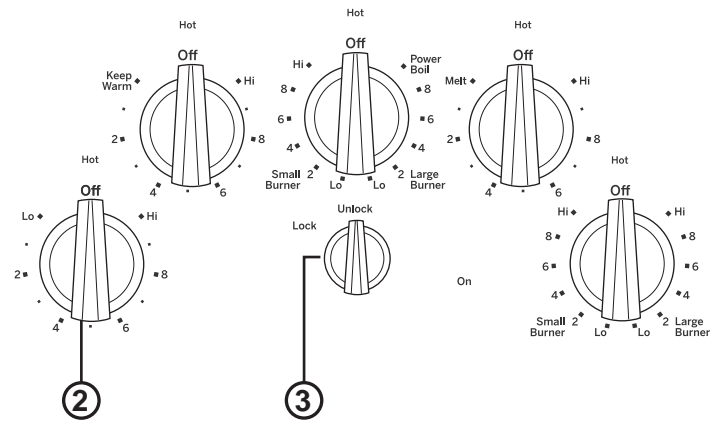

User Interface Controls

- 1. **Cooking Element(s):** See page 14.
- 2. **Control Knob(s):** See page 14.
- 3. **Lock:** See page 16.

Cooktop Features

Throughout this manual, features and appearance may vary from your model.

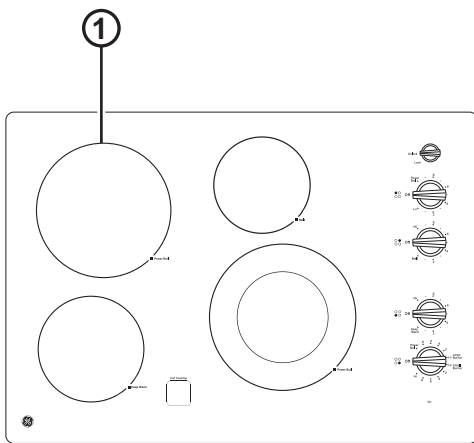

JP3530 cooktop

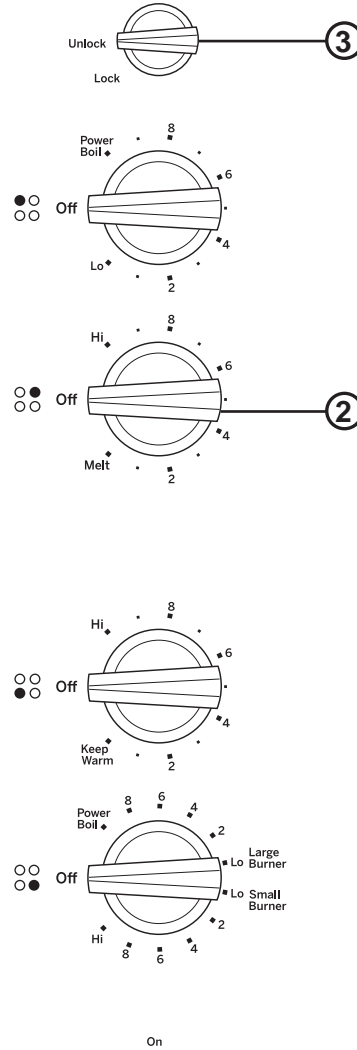

User Interface Controls

1. **Cooking Element(s):** See page 14.
2. **Control Knob(s):** See page 14.
3. **Lock:** See page 16.

Cooktop Features

Throughout this manual, features and appearance may vary from your model.

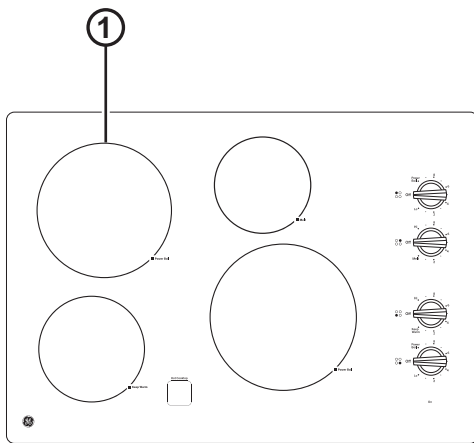

JP3030 cooktop

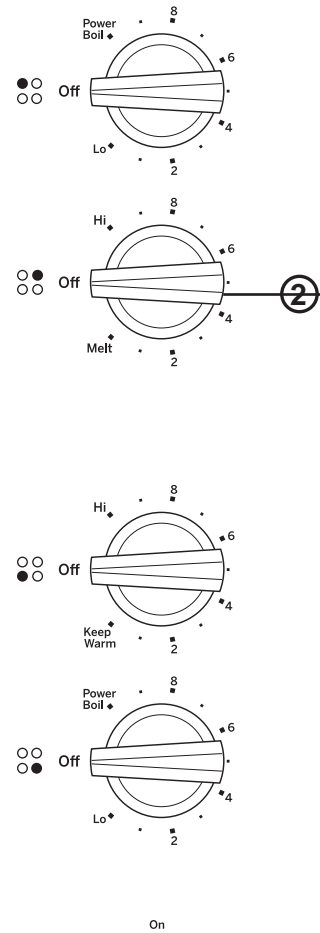

User Interface Controls

1. **Cooking Element(s):** See page 14.
2. **Control Knob(s):** See page 14.

Cooktop Features

Throughout this manual, features and appearance may vary from your model.

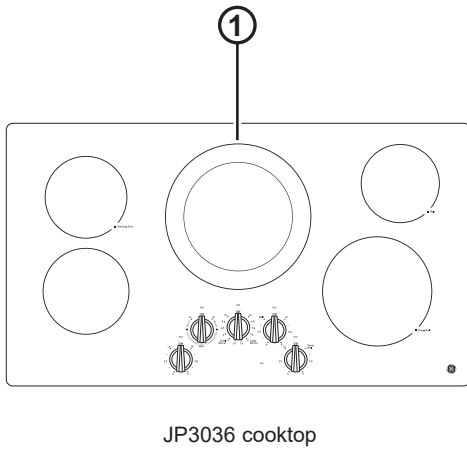

JP3036 cooktop

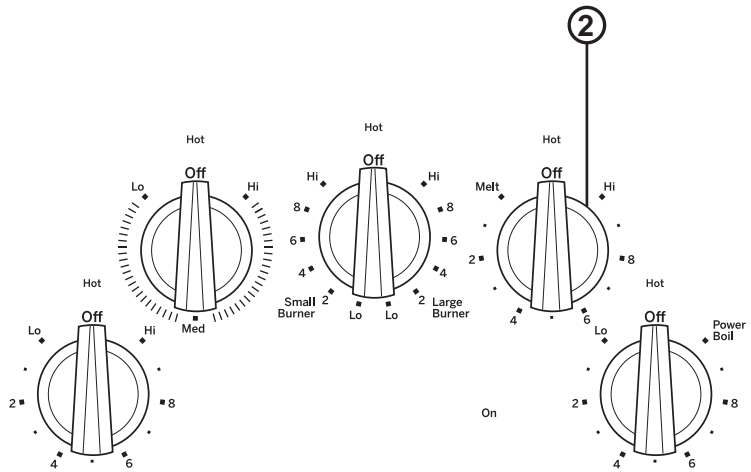

User Interface Controls

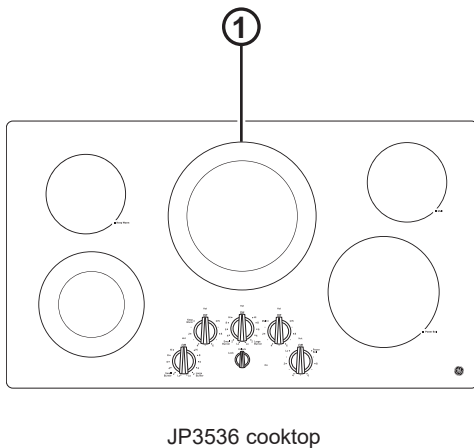

JP3536 cooktop

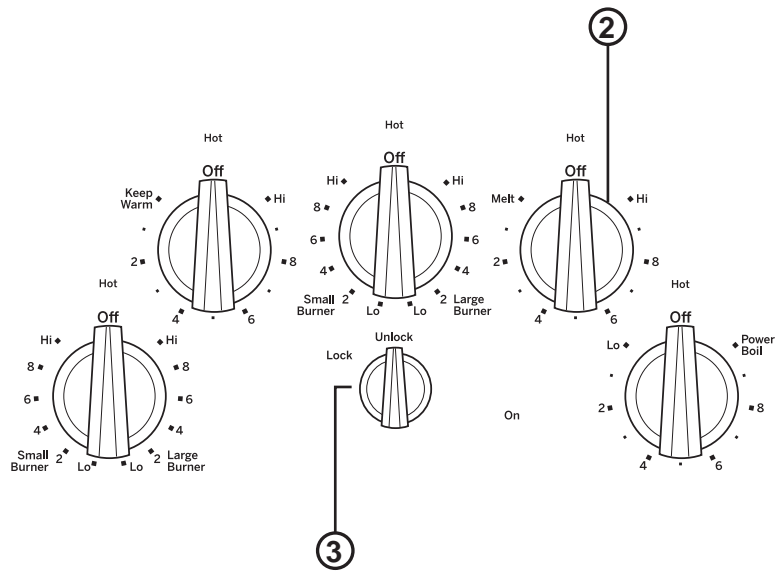

User Interface Controls

1. **Cooking Element(s):** See page 14.
2. **Control Knob(s):** See page 14.
3. **Lock:** See page 16.

Cooktop Features

Throughout this manual, features and appearance may vary from your model.

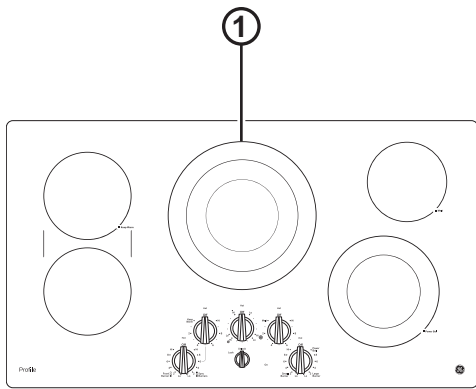

PP7036 cooktop

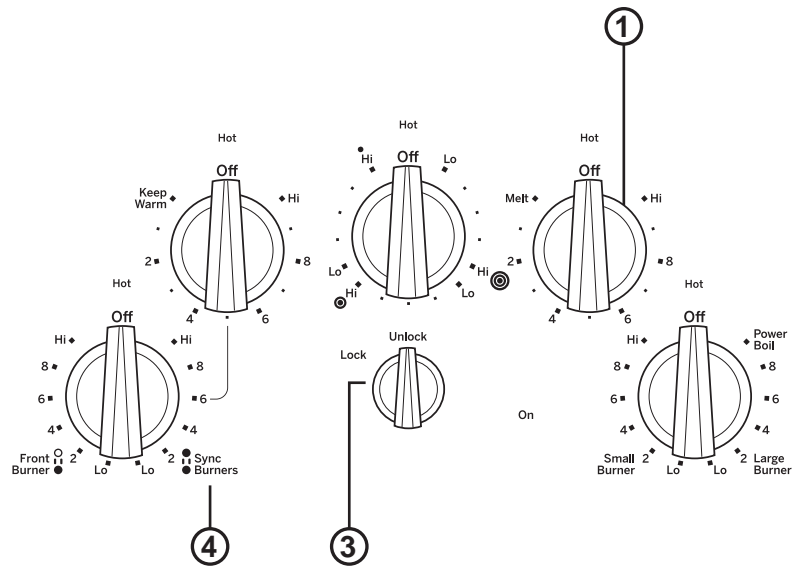

User Interface Controls

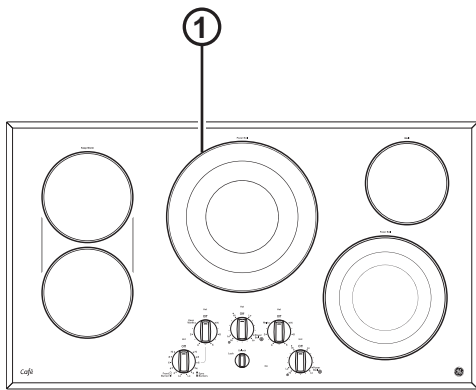

CP9536 cooktop

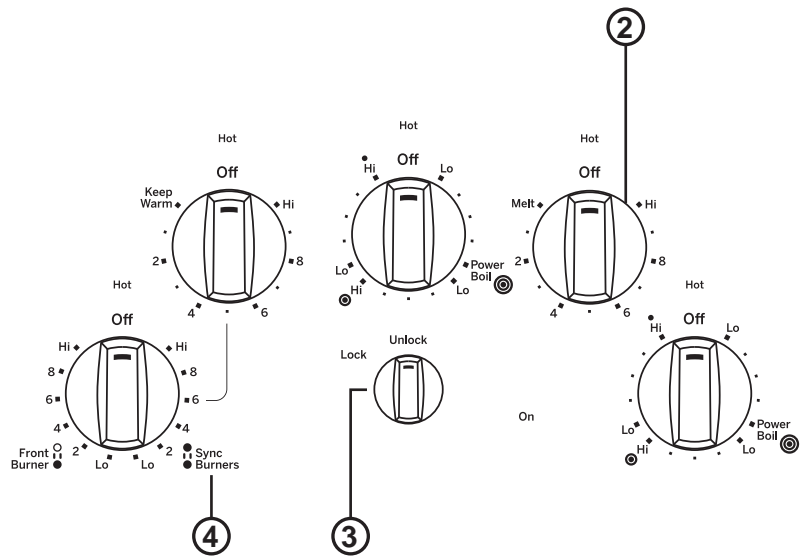

User Interface Controls

- 1. **Cooking Element(s):** See page 14.
- 2. **Control Knob(s):** See page 14.
- 3. **Lock:** See page 16.
- 4. **Sync Burners:** See page 15.

Cooktop Features

Throughout this manual, features and appearance may vary from your model.

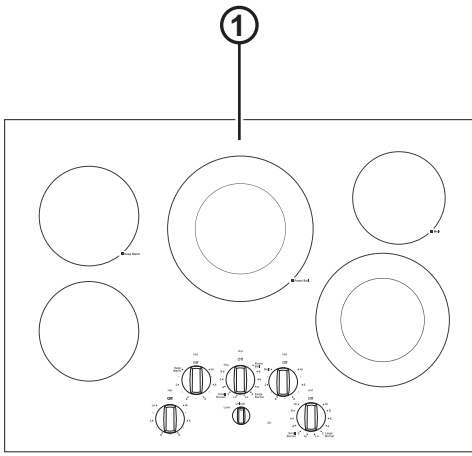

JEP5030 cooktop

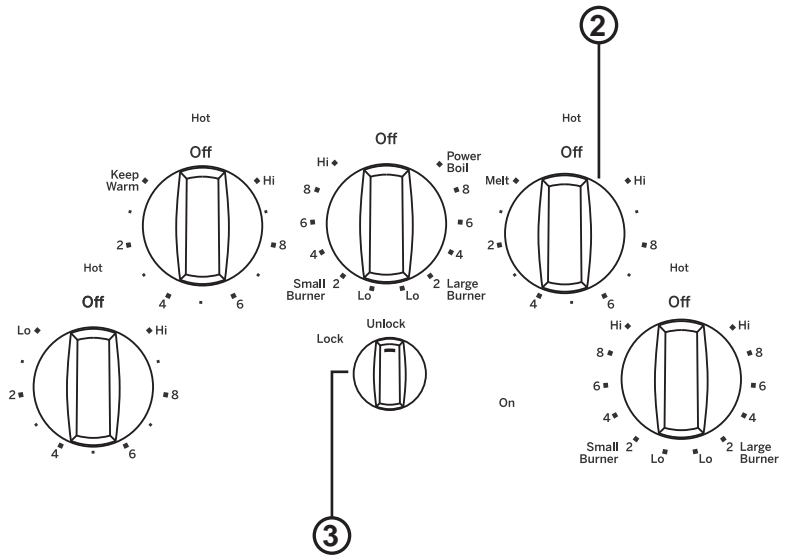

User Interface Controls

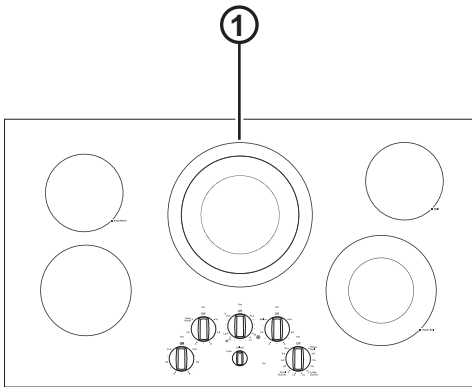

JEP5036 cooktop

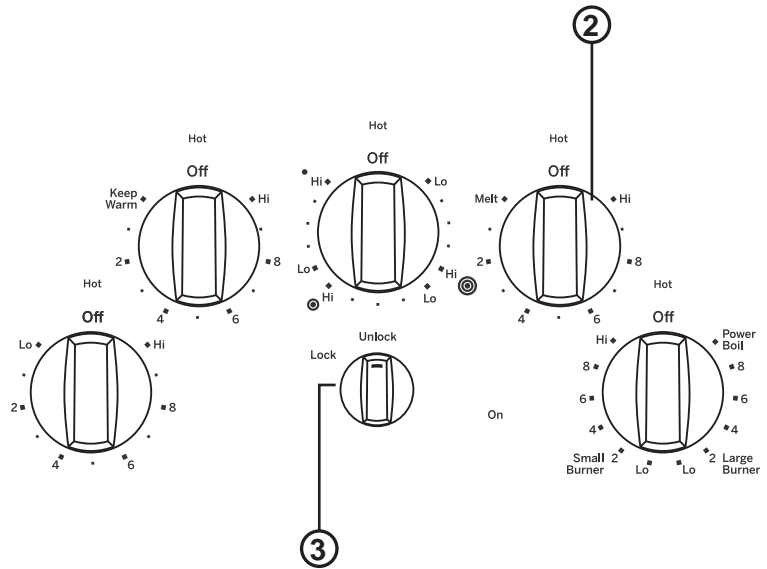

User Interface Controls

1. **Cooking Element(s):** See page 14.
2. **Control Knob(s):** See page 14.
3. **Lock:** See page 16.

Radiant Glass Cooktop

The radiant cooktop features heating units beneath a smooth glass surface.

NOTE: A slight odor is normal when a new cooktop is used for the first time. It is caused by the heating of new parts and insulating materials and will disappear in a short time.

NOTE: This cooktop has Rapid Response surface units. The cooktop will automatically heat up or cool down to the desired power level setting in the quickest time possible. While the surface units are on, you may not see them glow red during certain heat up or cool down conditions.

Cooktop temperatures increase with the number of surface units that are on. With 3 or 4 units turned on, surface temperatures are high. Always use caution when touching the cooktop.



Never cook directly on the glass.
Always use cookware.



Always place the pan in the center of the surface unit you are cooking on.

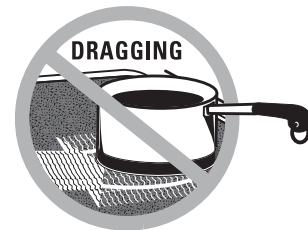

Do not slide cookware across the cooktop because it can scratch the glass—the glass is scratch-resistant, not scratch proof.

Home Canning Tips

Be sure the canner is centered over the surface unit.

Make sure the canner is flat on the bottom.

To prevent burns from steam or heat, use caution when canning.

Use recipes and procedures from reputable sources. These are available from manufacturers such as Ball® and Kerr® and the Department of Agriculture Extension Service.

Flat-bottomed canners are recommended. Use of water bath canners with rippled bottoms may extend the time required to bring the water to a boil.

Cookware for Radiant Glass Cooktop

The following information will help you choose cookware which will give good performance on glass cooktops.

NOTE: Follow all cookware manufacturer's recommendations when using any type of cookware on the ceramic cooktop.

Recommended

Stainless Steel

Aluminum:

Heavy weight recommended

Good conductivity. Aluminum residues sometimes appear as scratches on the cooktop but can be removed if cleaned immediately. Because of its low melting point, thin weight aluminum should not be used.

Copper Bottom:

Copper may leave residues which can appear as scratches. The residues can be removed, as long as the cooktop is cleaned immediately. However, do not let these pots boil dry. Overheated metal can bond to glass cooktops. An overheated copper bottom pot will leave a residue that will permanently stain the cooktop if not removed immediately.

Enamel (painted) on Cast Iron:

Recommended if bottom of pan is coated

Avoid/Not Recommended

Enamel (painted) on Steel:

Heating empty pans can cause permanent damage to cooktop glass. The enamel can melt and bond to the ceramic cooktop.

Glass-ceramic:

Poor performance. Will scratch the surface.

Stoneware:

Poor performance. May scratch the surface.

Cast Iron:

Not recommended—unless designed specifically for glass cooktops

Poor conductivity and slow to absorb heat. Will scratch the cooktop surface.

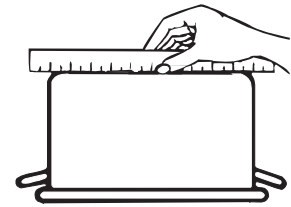

Check pans for flat bottoms by using a straight edge.

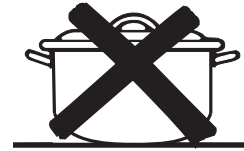

Pans with rounded, curved, ridged or warped bottoms are not recommended.

For Best Results

- Place only dry pans on the surface elements. Do not place lids on the surface elements, particularly wet lids. Wet pans and lids may stick to the surface when cool.
- Do not use woks that have support rings. This type of wok will not heat on glass surface elements.
- We recommend that you use only a flat-bottomed wok. They are available at your local retail store. The bottom of the wok should have the same diameter as the surface element to ensure proper contact.
- Some special cooking procedures require specific cookware such as pressure cookers or deep-fat fryers. All cookware must have flat bottoms and be the correct size.



Do not place wet pans on the glass cooktop.



Do not use woks with support rings on the glass cooktop.



Use flat-bottomed woks on the glass cooktop.

Element Cycling

Surface elements will cycle on and off to maintain the temperature you have selected. All radiant surface elements have a temperature limiter that protects the glass cooktop from getting too hot, this is normal. The temperature limiter may cycle the elements off more frequently if:

- The pan boils dry.
- The pan bottom is not flat.
- The pan is off-center.
- There is no pan on the element.

Turn Product On/Off

- Push the knob down and turn in either direction to the setting you want. When the control is in any position other than **Off**, it may be rotated without pushing it down. You may feel a slight bump when it is rotated through the **Lo** or **Hi** positions. You may hear slight clicking sounds during cooking, indicating the control is keeping the power level you set.
- A **HOT SURFACE** indicator light will glow when any radiant element is turned on and will remain on until the surface is cooled to approximately 150°F.
- Be sure you turn the control knob to **Off** when you finish cooking. It will snap into the **Off** position.

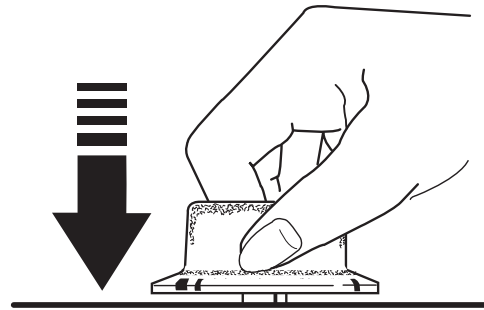



Operating The Cooking Elements

Dual Surface Element

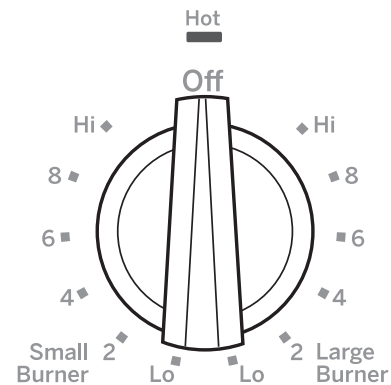
- To use the small surface element, turn the control knob to the **Small Burner** settings.
- To use the large surface element, turn the control knob to the **Large Burner** settings.



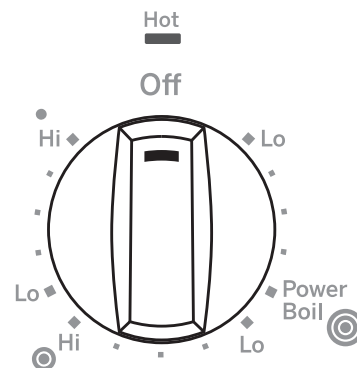

Tri-Ring Surface Element

- To use the large surface element, push and turn the center control knob clockwise to , stopping at the desired setting. This will activate the entire heating area.
- To use the medium surface element, push and turn the center control knob clockwise to , stopping at the desired setting. This will activate the medium-size heating area.
- To use the smallest surface element, push and turn the center control knob clockwise to , stopping at the desired setting. This will activate the smallest, inside heating area.



How To Synchronize Left Burners (on some models)

- Make sure the pan rests flat on the glass cooktop. Choose pans that match the circle/bridge area as closely as possible.
- To use both left elements at the same setting, push and turn the control knob to  Sync Burners, stopping at the desired settings. It is normal to hear a clicking noise when the elements are in sync mode.
- To use the left front surface element only, push and turn the control knob to  Front Burner, stopping at the desired settings.

Content just for the following models: CP9530, CP9536 and JP7030, JP7036 – Backlit Knobs.

When using Sync Burner the left rear knob lighting will slightly flicker. The rear element is controlled by the front element and briefly lights the knob as the two elements heat. This is normal.

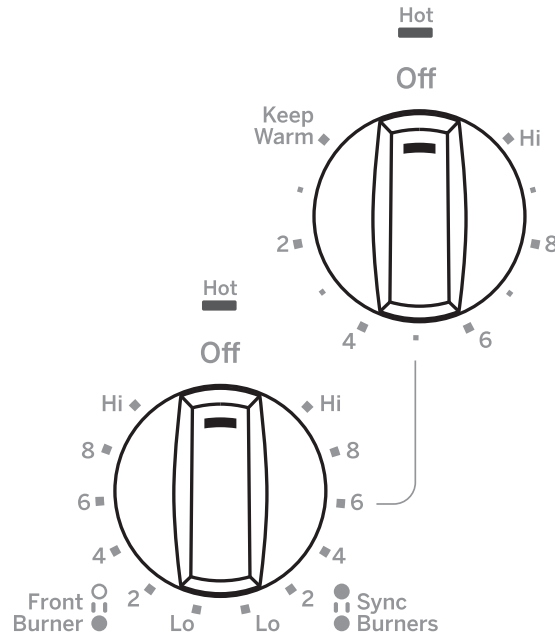

Selecting Cooktop Settings

Choose the element/burner that is the best fit to the cookware size. Each element/burner on your new cooktop has its own power levels ranging from low to high. Power level settings necessary for cooking will vary depending on the cookware being used, the type and quantity of food, and the desired outcome.

In general:

- Use lower settings for melting, holding, and simmering.
- Use higher settings for heating quickly, searing, and frying.
- For "Warming Zone" elements intended for holding (some models), use the Med-Hi settings.

When keeping foods warm confirm selected setting is sufficient to maintain food temperature above 140°F. Larger elements are not recommended for melting. Power boil elements are best suited for boiling water, particularly with pots that are 9" or larger.

NOTE: The "Warming Zone" element may not glow bright red like the cooking elements when in use.

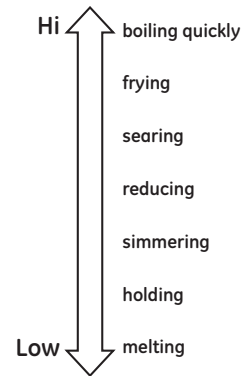

Cooktop Lockout (on some models)

To lock the cooktop and prevent unwanted use, turn the control lock knob to **Lock**. An indicator light will glow to show that the cooktop is locked. To unlock, press and turn the knob to **Unlock**. In the locked position, the cooktop will produce an audible sound if any control knob is set to a position other than **Off**.



Hot Light Indicator

A hot surface indicator light (one for each cooking element) will glow when the glass surface is hot and will remain on until the surface has cooled to temperature that is safe to touch.

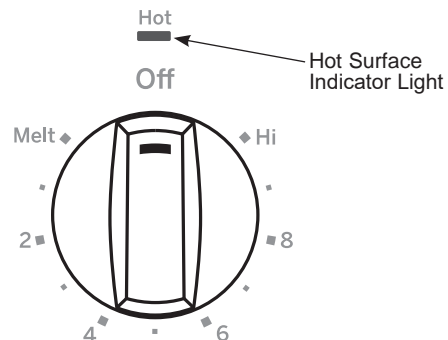

Griddle (optional accessory)

Using the Griddle

⚠ CAUTION Burn Hazard

- Griddle surfaces may be hot enough to cause burns during and after use. Place and remove the griddle when it is cool and all surface units are off. Use oven mitts if you will touch the griddle while hot. Failure to do so can result in burns.
- Place and remove the griddle only when griddle is cool and all surface burners are turned Off.

Before using this cookware for the first time, wash it to make sure it is clean. Then season it lightly, rubbing cooking oil onto the cooking surface.

How To Place The Griddle

IMPORTANT: Always place and use your griddle at the designated location on the cooktop.

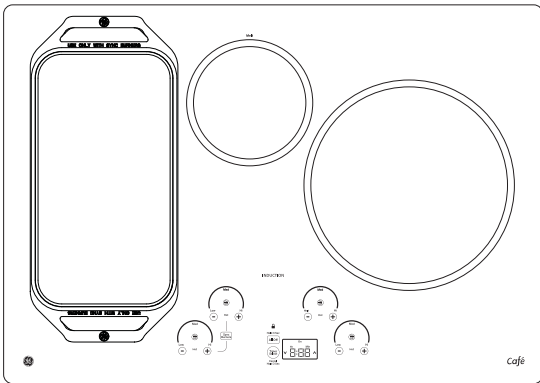

Type of Food	Cook Setting
Warming Tortillas	Med-Lo
Pancakes	Med-Lo
Hamburgers	Med
Fried Eggs	Med-Lo
Breakfast Sausage Links	Med
Hot Sandwiches (such as Grilled Cheese)	Med-Lo

Griddle settings are intended to be a guideline and may need to be adjusted based on individual cooking preferences.

Griddle Operation

To turn on the surface units for the entire griddle, use the Sync Burner control feature. Touch the **Sync Burner** pad and then adjust power level to desired setting as described on page 14.

IMPORTANT NOTES:

- Clean the griddle with a sponge and mild detergent in warm water. DO NOT use blue or green scrubbing pads or steel wool.
- Avoid cooking extremely greasy foods and be careful of grease spillover while cooking.
- Never place or store any items on the griddle, even when it is not in use. The griddle can become heated when using the surrounding surface units.
- Avoid using metal utensils with sharp points or rough edges, which might damage the griddle. Do not cut foods on the griddle.
- Do not use cookware as a storage container for food or oil. Permanent staining and/or craze lines could result.
- Your griddle will discolor over time with use.
- Do not clean the griddle in a self-cleaning oven.
- Always allow the cookware to cool before immersing in water.
- Do not overheat the griddle.

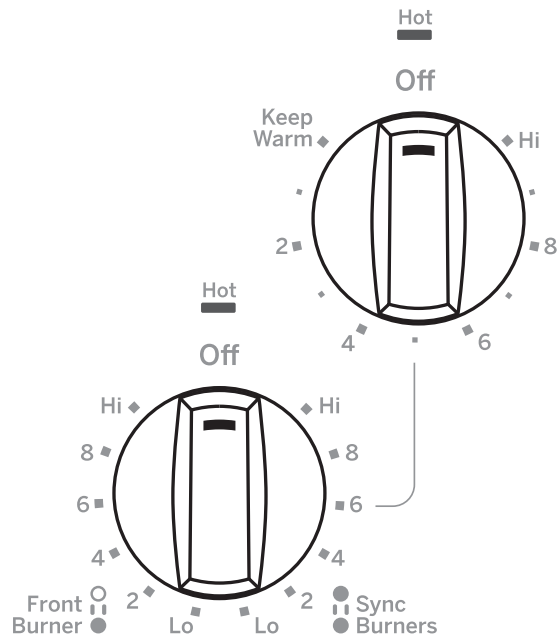

Cleaning the Glass Cooktop

To maintain and protect the surface of your glass cooktop, follow these steps:

1. Before using the cooktop for the first time, clean it with a ceramic cooktop cleaner. This helps protect the top and makes cleanup easier.
2. Regular use of a ceramic cooktop cleaner will help keep the cooktop looking new.
3. Shake the cleaning cream well. Apply a few drops of a ceramic cooktop cleaner directly to the cooktop.
4. Use a paper towel or a non-scratch cleaning pad for ceramic cooktops to clean the entire cooktop surface.
5. Use a dry cloth or paper towel to remove all cleaning residue. No need to rinse.

NOTE: It is very important that you DO NOT heat the cooktop until it has been cleaned thoroughly.

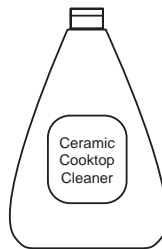

Clean your cooktop after each spill. Use a ceramic cooktop cleaner.



For cleaning videos and instructions, scan the QR code with your device.

Burned-On Residue

NOTE: DAMAGE to your glass surface may occur if you use scrub pads other than those recommended.

1. Allow the cooktop to cool.
2. Spread a few drops of a ceramic cooktop cleaner on the entire burned residue area.
3. Using a non-scratch cleaning pad for ceramic cooktops, rub the residue area, applying pressure as needed.
4. If any residue remains, repeat the steps listed above as needed.

5. For additional protection, after all residue has been removed, polish the entire surface with a ceramic cooktop cleaner and a paper towel.

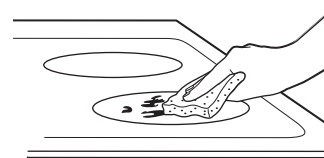

Use a non-scratch cleaning pad for ceramic cooktops.

Heavy, Burned-On Residue

1. Allow the cooktop to cool.
2. Use a single-edge razor blade scraper at approximately a 45° angle against the glass surface and scrape the soil. It will be necessary to apply pressure to the razor scraper in order to remove the residue.
3. After scraping with the razor scraper, spread a few drops of a ceramic cooktop cleaner on the entire burned residue area. Use a non-scratch cleaning pad to remove any remaining residue.
4. For additional protection, after all residue has been removed, polish the entire surface with a ceramic cooktop cleaner and a paper towel.

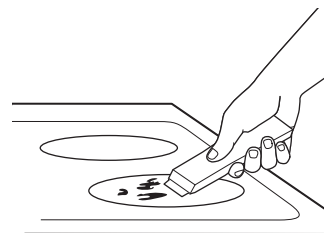

The ceramic cooktop scraper and all recommended supplies are available through our Parts Center. See instructions under "Assistance / Accessories" section.

NOTE: Do not use a dull or nicked blade.

Cleaning the Glass Cooktop

Metal Marks and Scratches

1. Be careful not to slide pots and pans across your cooktop. It will leave metal markings on the cooktop surface.

These marks are removable using a ceramic cooktop cleaner with a non-scratch cleaning pad for ceramic cooktops.

2. If pots with a thin overlay of aluminum or copper are allowed to boil dry, the overlay may leave black discoloration on the cooktop.

This should be removed immediately before heating again or the discoloration may be permanent.

NOTE: Carefully check the bottom of pans for roughness that would scratch the cooktop.

3. Be careful not to place aluminum baking sheets or aluminum frozen entrée containers on a hot cooktop surface. It will leave shiny dots or markings on the cooktop surface. These markings are permanent and cannot be cleaned off.

Damage from Sugary Spills and Melted Plastic

Special care should be taken when removing hot substances **to avoid permanent damage of the glass surface**. Sugary spillovers (such as jellies, fudge, candy, syrups) or melted plastics can cause pitting of the surface of your cooktop (not covered by the warranty) unless the spill is removed while still hot. Special care should be taken when removing hot substances.

Be sure to use a new, sharp razor scraper.

Do not use a dull or nicked blade.

1. Turn off all surface units. Remove hot pans.
2. Wearing an oven mitt:
 - a. Use a single-edge razor blade scraper to move the spill to a cool area on the cooktop.
 - b. Remove the spill with paper towels.
3. Any remaining spillover should be left until the surface of the cooktop has cooled.
4. Don't use the surface units again until all of the residue has been completely removed.

NOTE: If pitting or indentation in the glass surface has already occurred, the cooktop glass will have to be replaced. In this case, service will be necessary.

Cleaning Trim

Do not use a steel wool or green pad; it will scratch the surface.

To clean the stainless steel surface, use warm sudsy water or a stainless steel cleaner or polish. Always wipe the surface in the direction of the grain. Follow the cleaner instructions for cleaning the stainless steel surface. To inquire about purchasing stainless steel appliance cleaner or polish, or to find the location of a dealer nearest you, please call our toll-free number: National Parts Center: 877.959.8688 (GEApplianceparts.com)

Cleaning Knobs

The control knobs may be removed for easier cleaning. Make sure the knobs are in the **Off** positions and pull them straight off the stems for cleaning. The knobs can be cleaned in a dishwasher or they may also be washed with soap and water. Make sure the insides of the knobs are dry before replacing. Replace the knobs in the **Off** position to ensure proper placement.

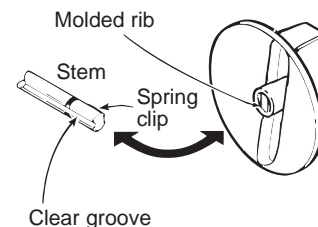

Troubleshooting Tips ... Before you call for service

Save time and money! Review the charts on the following pages first and you may not need to call for service. If an error occurs in the control operation, a fault code will flash in the display. Record the error code and call for service. Check out self-help videos and FAQ at GEAppliances.com/support.

Problem	Possible Cause	What To Do
Surface elements will not maintain a rolling boil or cooking is slow	Improper cookware being used.	Use pans that are absolutely flat and match the diameter of the surface unit selected.
Surface elements do not work properly	Cooktop controls improperly set.	Check to be sure the correct control is set for the surface element you are using.
Scratches on cooktop glass surface	Incorrect cleaning methods being used.	Use recommended cleaning procedures. See the Cleaning the glass cooktop section.
	Cookware with rough bottoms being used or coarse particles (salt or sand) were between the cookware and the surface of the cooktop. Cookware has been slid across the cooktop surface.	To avoid scratches, use the recommended cleaning procedures. Make sure bottoms of cookware are clean before use, and use cookware with smooth bottoms.
Areas of discoloration on the cooktop	Food spillovers not cleaned before next use.	See the Cleaning the glass cooktop section.
	Hot surface on a model with a light-colored glass cooktop.	This is normal. The surface may appear discolored when it is hot. This is temporary and will disappear as the glass cools.
Plastic melted to the surface	Hot cooktop came into contact with plastic placed on the hot cooktop.	See the Glass surface – potential for permanent damage section in the Cleaning the glass cooktop section.
Pitting (or indentation) of the cooktop	Hot sugar mixture spilled on the cooktop.	Call a qualified technician for replacement.

Notes

GE Appliances Limited Warranty

GEAppliances.com

All warranty service is provided by our Factory Service Centers, or an authorized Customer Care® technician. To schedule service online, visit us at GEAppliances.com/service, or call GE Appliances at 800.GE.CARES (800.432.2737). Please have your serial number and your model number available when calling for service.

Servicing your appliance may require the use of the onboard data port for diagnostics. This gives a GE Appliances factory service technician the ability to quickly diagnose any issues with your appliance and helps GE Appliances improve its products by providing GE Appliances with information on your appliance. If you do not want your appliance data to be sent to GE Appliances, please advise your technician not to submit the data to GE Appliances at the time of service.

For the period of	GE Appliances will replace
One year From the date of the original purchase	Any part of the cooktop which fails due to a defect in materials or workmanship. During this limited one-year warranty , GE Appliances will provide, free of charge , all labor and in-home service to replace the defective part.

What GE Appliances will not cover:

- Service trips to your home to teach you how to use the product.
- Improper installation, delivery or maintenance.
- Failure of the product if it is abused, misused, modified or used for other than the intended purpose or used commercially.
- Damage to the glass cooktop caused by use of cleaners other than the recommended cleaning creams and pads.
- Damage to the glass cooktop caused by hardened spills of sugary materials or melted plastic that are not cleaned according to the directions in the Owner's Manual.
- Replacement of house fuses or resetting of circuit breakers.
- Damage to the product caused by accident, fire, floods or acts of God.
- Incidental or consequential damage caused by possible defects with this appliance.
- Damage caused after delivery.
- Product not accessible to provide required service.
- Service to repair or replace light bulbs, except for LED lamps.
- Effective January 1, 2022, cosmetic damage to the glass cooktop such as, but not limited to, chips, scratches, or baked on residue not reported within 90 days of installation.
- Effective January 1, 2022, damage to the glass cooktop due to impact or misuse. See example.



Staple your receipt here. Proof of the original purchase date is needed to obtain service under the warranty.

EXCLUSION OF IMPLIED WARRANTIES

Your sole and exclusive remedy is product repair as provided in this Limited Warranty. Any implied warranties, including the implied warranties of merchantability or fitness for a particular purpose, are limited to one year or the shortest period allowed by law.

This limited warranty is extended to the original purchaser and any succeeding owner for products purchased for home use within the USA. If the product is located in an area where service by a GE Appliances Authorized Servicer is not available, you may be responsible for a trip charge or you may be required to bring the product to an Authorized GE Appliances Service location for service. In Alaska, the limited warranty excludes the cost of shipping or service calls to your home.

Some states do not allow the exclusion or limitation of incidental or consequential damages. This limited warranty gives you specific legal rights, and you may also have other rights which vary from state to state. To know what your legal rights are, consult your local or state consumer affairs office or your state's Attorney General.

Warrantor: GE Appliances, a Haier company

Louisville, KY 40225

Warrantor in Canada: MC Commercial

Burlington, ON, L7L 6C7

Extended Warranties: Purchase a GE Appliances extended warranty and learn about special discounts that are available while your warranty is still in effect. You can purchase it online anytime at

GEAppliances.com/extended-warranty

or call 800.626.2224 during normal business hours. GE Appliances Service will still be there after your warranty expires.

Accessories

Looking For Something More?

GE Appliances offers a variety of accessories to improve your cooking and maintenance experiences!

Refer to the Consumer Support page for phone numbers and website information.

The following products and more are available:

Parts

Griddle

Stainless Steel Cleaner and Polisher

Consumer Support

GE Appliances Website

Have a question or need assistance with your appliance? Try the GE Appliances Website 24 hours a day, any day of the year! You can also shop for more great GE Appliances products and take advantage of all our on-line support services designed for your convenience. In the US: **GEAppliances.com** In Canada: **GEAppliances.ca**

Register Your Appliance

Register your new appliance on-line at your convenience! Timely product registration will allow for enhanced communication and prompt service under the terms of your warranty, should the need arise. You may also mail in the pre-printed registration card included in the packing material.

In the US: **GEAppliances.com/register**

In Canada: **Prodsupport.mabe.ca/crm/Products/ProductRegistration.aspx**

Schedule Service

Expert GE Appliances repair service is only one step away from your door. Get on-line and schedule your service at your convenience any day of the year.

In the US: **GEAppliances.com/service** or call 800.432.2737 during normal business hours.

In Canada: **GEAppliances.ca/en/support/service-request** or call 800.561.3344

Extended Warranties

Purchase a GE Appliances extended warranty and learn about special discounts that are available while your warranty is still in effect. You can purchase it on-line anytime. GE Appliances Services will still be there after your warranty expires.

In the US: **GEAppliances.com/extended-warranty** or call 800.626.2224 during normal business hours.

In Canada: **GEAppliances.ca/en/support/purchase-extended-warranty** or call 800.290.9029

Remote Connectivity

For assistance with wireless network connectivity (for models with remote enable), visit our website at **GEAppliances.com/connect** or call 800.220.6899 in the US only.

Parts and Accessories

Individuals qualified to service their own appliances can have parts or accessories sent directly to their homes (VISA, MasterCard and Discover cards are accepted). Order on-line today 24 hours every day.

In the US: **GEApplianceparts.com** or by phone at 877.959.8688 during normal business hours.

Instructions contained in this manual cover procedures to be performed by any user. Other servicing generally should be referred to qualified service personnel. Caution must be exercised, since improper servicing may cause unsafe operation.

Customers in Canada should consult the yellow pages for the nearest Mabe service center, visit our website at **GEAppliances.ca/en/products/parts-filters-accessories** or call 800.661.1616.

Contact Us

If you are not satisfied with the service you receive from GE Appliances, contact us on our Website with all the details including your phone number, or write to:

In the US: General Manager, Customer Relations | GE Appliances, Appliance Park | Louisville, KY 40225
GEAppliances.com/contact

In Canada: Director, Consumer Relations, Mabe Canada Inc. | Suite 310, 1 Factory Lane | Moncton, N.B. E1C 9M3
GEAppliances.ca/en/contact-us
