



WASHERS

SAFETY INFORMATION 3

USING THE WASHER

Getting Started 5

Appliance Communication 14

Dryer Control 15

Dispensers 16

Consumer Help Indicator 18

Loading 19

CARE AND CLEANING 20

INSTALLATION INSTRUCTIONS 22

Reversing The Door Swing (optional on some models only)..... 27

TROUBLESHOOTING TIPS..... 31

LIMITED WARRANTY 35

CONSUMER SUPPORT 36

QUICK REFERENCE GUIDE 37

QUICK INSTALLATION GUIDE .. 38

OWNER'S MANUAL & INSTALLATION INSTRUCTIONS

- PFW950
- PFW870
- GFW850
- GFW655
- GFW650
- GFW550
- GFW510

ENGLISH/FRANÇAIS/ESPAÑOL

Write the model number, serial number and MAC ID for WiFi enabled models here:

Model # _____

Serial # _____

MAC ID _____

You can find them on a label inside the washer door.

THANK YOU FOR MAKING GE APPLIANCES A PART OF YOUR HOME.

Whether you grew up with GE Appliances, or this is your first, we're happy to have you in the family.

We take pride in the craftsmanship, innovation and design that goes into every GE Appliances product, and we think you will too. Among other things, registration of your appliance ensures that we can deliver important product information and warranty details when you need them.

Register your GE appliance now online. Helpful websites and phone numbers are available in the Consumer Support section of this Owner's Manual. You may also mail in the pre-printed registration card included in the packing material.



IMPORTANT SAFETY INFORMATION

READ ALL INSTRUCTIONS BEFORE USING THE APPLIANCE

▲ WARNING

To reduce the risk of death, fire, explosion, electric shock, or injury to persons when using your appliance, follow basic precautions, including the following:

- Read all instructions before using the appliance.
- Follow all fabric care instructions and warnings to prevent melting of garments or damage to the appliance.
- **DO NOT** wash or dry articles that have been previously cleaned in, washed in, soaked in or spotted with gasoline, dry-cleaning solvents, or other flammable or explosive substances, as they give off vapors that could ignite or explode.
- **DO NOT** add gasoline, dry-cleaning solvents, or other flammable or explosive substances to the wash water. These substances give off vapors that could ignite or explode.
- Under certain conditions, hydrogen gas may be produced in a hot-water system that has not been used for 2 weeks or more. **HYDROGEN GAS IS EXPLOSIVE.** If the hot water system has not been used for such a period, before using a washing machine, turn on all hot-water faucets and let the water flow from each for several minutes. This will release any accumulated hydrogen gas. As the gas is flammable, **DO NOT** smoke or use an open flame during this time.
- **DO NOT** allow children to play on or in this appliance. Close supervision of children is necessary when this appliance is used near children. Before the washer is removed from service or discarded, remove the door or lid. Failure to follow these instructions may result in death or injury to persons.
- **DO NOT** reach into the appliance if the tub or agitator is moving to prevent accidental entanglement.
- **DO NOT** install or store this appliance where it will be exposed to the weather.
- **DO NOT** tamper with controls, repair or replace any part of this appliance or attempt any servicing unless specifically recommended in the user maintenance instructions or in published user repair instructions that you understand and have the skills to carry out.
- **DO NOT** climb or stand on this unit.
- **DO NOT** operate this appliance if it is damaged, malfunctioning, partially disassembled, or has missing or broken parts including a damaged cord or plug.
- Unplug the appliance or turn off the circuit breaker before servicing. Pressing the **Power** pad **DOES NOT** disconnect power.
- See “ELECTRICAL REQUIREMENTS” located in the Installation Instructions for grounding instructions.
- **DO NOT** use replacement parts that have not been recommended by the manufacturer. (e.g. parts made at home using a 3D printer).

Proper Disposal of your Appliance

- Dispose of or recycle your appliance in accordance with Federal and Local Regulations. Contact your local authorities for the environmentally safe disposal or recycling of your appliance.

READ AND SAVE THESE INSTRUCTIONS

IMPORTANT SAFETY INFORMATION

READ ALL INSTRUCTIONS BEFORE USING THE APPLIANCE

PROPER INSTALLATION

This washer must be properly installed and located in accordance with the Installation Instructions before it is used.

- Ensure that the hot water hose is connected to the “H” valve and the cold water hose is connected to the “C” valve.
- Install or store where it will not be exposed to temperatures below freezing or exposed to the weather, which could cause permanent damage and invalidate the warranty.
- Properly ground washer to conform with all governing codes and ordinances. Follow details in the Installation Instructions.
- Ensure washer is properly leveled and washer legs are adjusted such that unit is stable.
- Optional drain hose extension recommended for discharging heights from 60” - 96”.
- GE Appliances strongly recommends the use of factory specified parts. A list of factory hoses available for purchase are listed. These hoses are manufactured and tested to meet GE Appliances specifications.
- GE Appliances strongly recommends the use of new water supply hoses. Hoses degrade over time and need to be replaced every 5 years to reduce the risk of hose failures and water damage.
- Consider recycling options for your appliance packaging material.

AUTOMATIC DRAIN SEQUENCE

- Machine will automatically drain any time the door is left open for more than 15 minutes and water is present.
- Machine will automatically drain if left in a paused state with the door closed for more than 24 hours and water is present.

WHEN NOT IN USE

- Turn off water faucets to minimize leakage if a break or rupture should occur. Check the condition of the fill hoses; GE Appliances recommends changing the hoses every 5 years.

PARTS AND ACCESSORIES

Order on-line at GEApplianceparts.com today, 24 hours a day or by phone at 877.959.8688 during normal business hours. In Canada, visit your local GE Appliances parts distributor or call 800.661.1616 or GEAppliances.ca/en/products/parts-filters-accessories.

Part Number	Accessory
WX14X10011	6 ft stainless steel washer hoses with 90° elbows; 2-pack
WH49X316	Washer drain hose extension kit - Approximately 44”
WX10X10011	Tide® Washing Machine Cleaner*
PM7X2	Universal low profile washer floor tray
GFA28KITN	Stack Bracket Kit (to stack dryer on top)
GFP1528S	28” width Pedestal with drawer – White
GFP1528P	28” width Pedestal with drawer – Colors
GFR0728S	28” width Riser without drawer – White
GFR0728P	28” width Riser without drawer – Colors

*Tide® is a registered trademark of Procter & Gamble

READ AND SAVE THESE INSTRUCTIONS

Using the washer

⚠ WARNING To reduce the risk of fire, electric shock, or injury to persons, read the IMPORTANT SAFETY INFORMATION before operating this appliance.

Throughout this manual, features and appearance may vary from your model.

Quick Start:

Step 1

Load clothes into your washer and close the door.



Step 2

If the screen is dark, press the Power pad or turn the knob to “wake up” the display.



Step 3

Turn the knob to select the desired cycle.

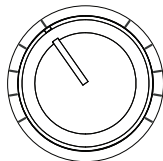

(cycle options vary by model)

Step 4

Open the dispenser and add detergent, bleach and fabric softener, as desired. Models with SmartDispense™ only require that you select the SmartDispense pad once the tank has been filled.

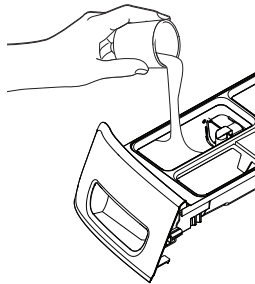

Step 5

Press Start to begin the wash cycle. The machine will weigh your clothes and add the proper amount of water. When the wash cycle is finished, the door will unlock.



Step 6 (on some models)

After the wash cycle is completed and the clothes unloaded, select **ULTRAFRESH VENT™** to help eliminate the excess moisture in your washer so you can close the door.



Display and Status Lights

(Features and appearance will vary)



On some models, the display shows the approximate time remaining until the end of the cycle and the washer cycle status (**Prewash, Fill, Wash, Rinse** and **Spin**).

NOTE: The cycle time is affected by how long it takes the washer to fill. This depends on the water pressure in your home. The “smart” timer “learns” the amount of time it takes to fill your washer and adjusts the total time accordingly.

On some models, if an out-of-balance condition is detected by the washer, the **Spin** status light or **Spin** option selection light will blink during the remaining portion of the cycle and will stay illuminated for a short time after cycle completion. When this occurs, the washer is taking actions to correct the out-of-balance condition and complete the cycle normally. In some cases, the washer may not be able to balance the load and spin up to full speed. If you notice the load is more wet than usual at the end of the cycle, redistribute the load evenly in the wash tub and run a **Rinse & Spin** cycle.

In addition, the display will show:

(WiFi) (on some models)	Will allow your appliance to communicate with your smartphone for remote appliance monitoring, control and notifications. It stays lit whenever the washer is on and is connected. It will blink during the commissioning process or if it loses connection to the network.
Venting (on some models)	Venting will blink to indicate that you can select the ULTRAFRESH VENT feature at the end of the cycle. It then stays illuminated once selected until venting is complete.
Control	The controls on the washer are locked when this icon is illuminated. You must press and hold the Control Lock pad to unlock the controls.
Door	This icon will illuminate while the door is locked and will blink while the washer is in the process of pausing and then unlocking.
Smart	This icon will illuminate when the Smart AI features of your washer are active.
Auto, More, Less (on some models)	The SmartDispense will automatically dose detergent according to the weight and soil level of the clothes. You can adjust this feature to dose MORE or LESS detergent or turn it OFF to manually dose detergent.
Tank Low (on some models)	At start up the unit displays when the SmartDispense tank needs to be re-filled. Typically, this first lights up when there are approximately 8 - 10 loads of detergent remaining.
Loads Left (on some models)	Displays the estimated number of wash loads left for the amount of detergent in the SmartDispense tank.
Delay (on some models)	When you select a delay start to your wash, this will be indicated by either a light next to the pad or with the word “Delay” in the center of the options window. The display will also countdown the hours until the cycle begins.

Getting started

Features and appearance will vary.

Model:
PFW950

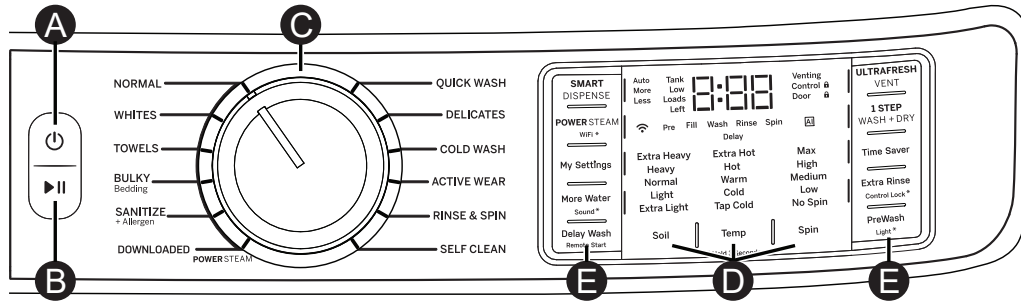

Model:
PFW870

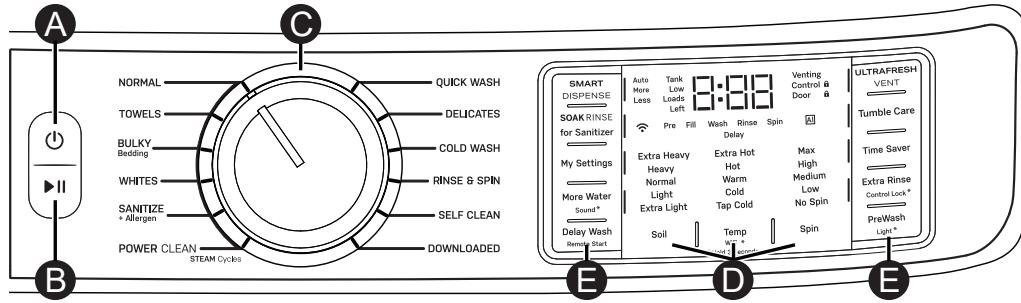

Model:
GFW850

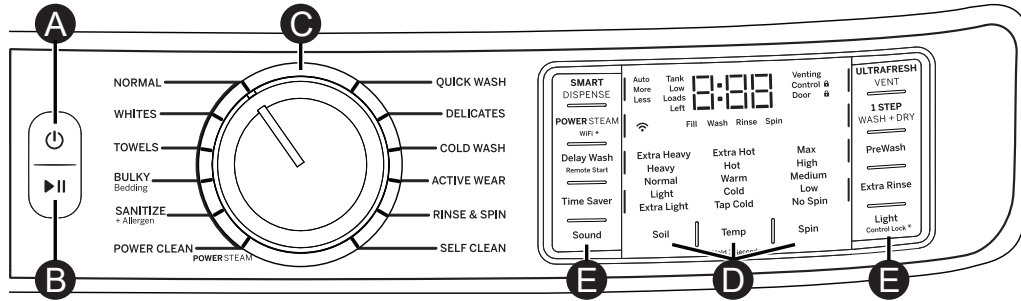

Model:
GFW655

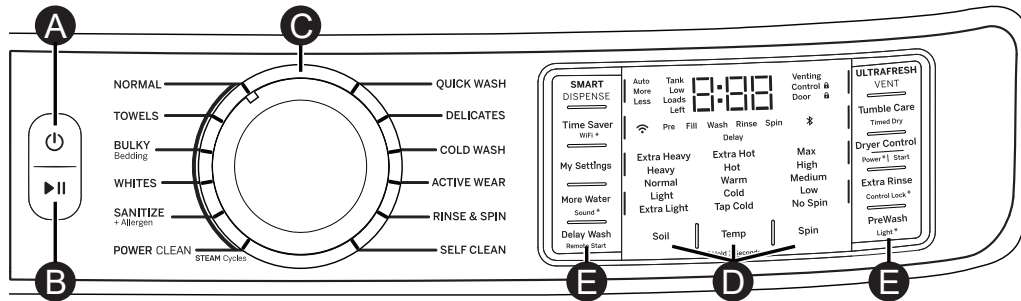

Model:
GFW650

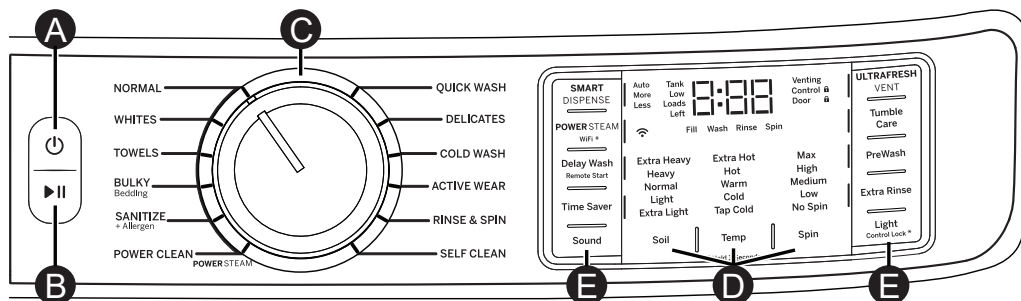

Getting started

Features and appearance will vary.

**Model:
GFW550**

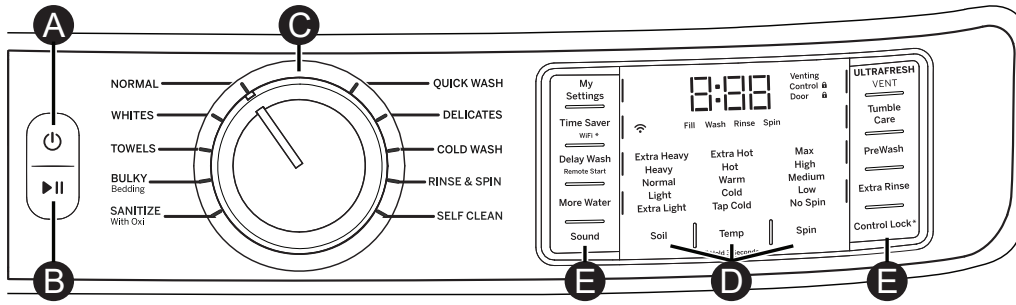

**Model:
GFW510SC**

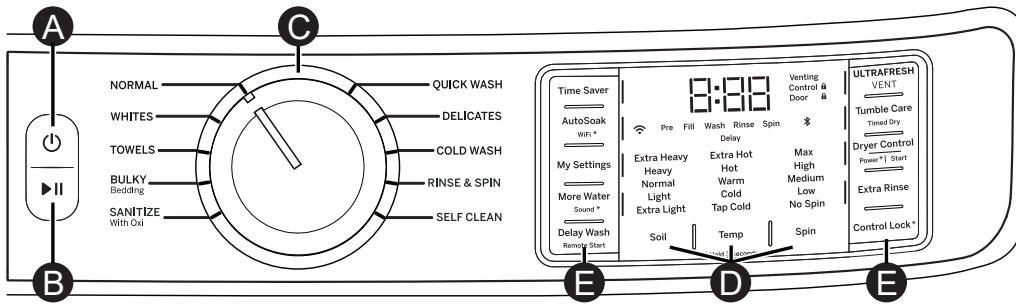

**Model:
GFW510SS**

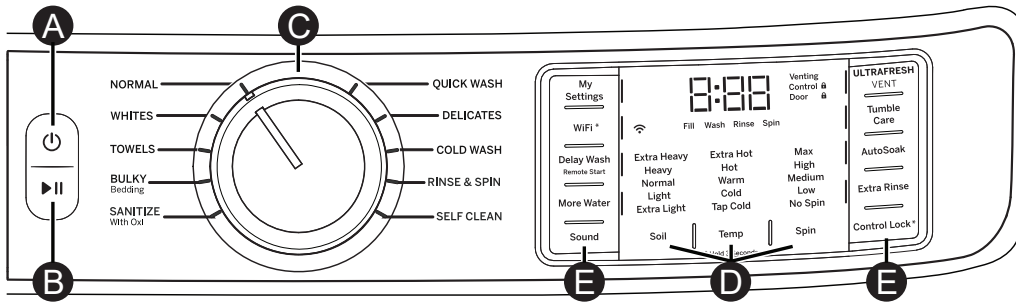

Using the washer

- A Power**
Press to “wake up” the display. If the display is active, press to put the washer into standby “OFF” mode.
NOTE: Pressing **Power** does not disconnect the appliance from the power supply.
- B Start and Pause (Add Garment)**
Press to start a wash cycle. If the washer is running, pressing it once will pause the washer and unlock the door, allowing **Add Garment** (should be done early in the wash cycle) or removal of a garment. It will take a few seconds for the door to unlock after pressing **Start/Pause**. After adding or removing garments, press again to restart the wash cycle.
NOTE: If washer is paused and cycle is not restarted within 15 minutes, the current wash cycle will be cancelled.
NOTE: The washer performs automatic system checks after pressing the **Start** pad. Water will flow in 45 seconds or less. You may hear the door lock and unlock and the pump activate before water flows.
- C Wash Cycles**
The cycles are optimized for specific types of loads. The chart below will help you match the items to be laundered with the best cycle settings. For optimal performance, select the cycle that most closely matches the items in your load. **Delay Start/Remote Start** is available on all cycles.

Cycle	Recommended Items
Normal	Cycle for normal, regular, or typical use for washing up to a full load of normally soiled cotton clothing.
Delicates	Lingerie and special care fabrics with light soil.
Towels	Towels, sheets, pillowcases and dish rags.
Bulky Bedding	Comforters, large coats, bed spreads, mattress covers, sleeping bags, and similar large bulky items.
Sanitize+ Allergen*	Heavily soiled colorfast items with the need for sanitization.
Sanitize With Oxi*	Heavily soiled colorfast items with the need for sanitization.
Active Wear	Medium to lightly soiled athletic wear items of technical or synthetic fabrics.
Quick Wash	Small loads of lightly soiled items that are needed in a hurry.
Whites	Whites and household linens.
Rinse and Spin	For items that need only to be rinsed and not washed. Rinse & Spin , or Drain & Spin (Extra Rinse deselected) . A spin is always performed unless you select No Spin .
Cold Wash	Cycle for normal, regular, or typical use for washing up to a full load of normally soiled cotton clothing using only cold water while delivering equivalent performance to Normal Warm wash.
Downloaded	Use the SmartHQ App to download a specialty cycle for your washer.
Power Clean	For heavily soiled items which require extra cleaning power.
Heavy Duty*	For washing heavily soiled, sturdy colorfast items using extended wash motions and rinses to deliver extra cleaning.
Jeans	Jeans with medium to light soil.
Swim Wear	Swim wear with medium to light soil.
Self Clean	Cleaning the basket of residue and odor. No clothes are to be washed using this cycle.

*Some cycles and options may not be available on some models.

NOTES:

The **SANITIZE + Allergen** cycle’s water temperatures CANNOT be changed. This cycle utilizes elevated water temperature and a longer wash cycle to kill dust mites and reduce 99% of common bacteria from fabrics. A pump purge and extended rinse is incorporated for the purpose of removing contaminants and allergens, such as pet dander. The **SANITIZE With Oxi** cycle’s water temperatures CANNOT be changed. This cycle, when using an Oxi additive along with your detergent, is designed to remove 99% of bacteria found in home laundry. Measure the detergent and the Oxi products carefully. Using the amounts appropriate for a large heavily soiled load in a front load washer, follow the detergent and the Oxi product label instructions. The washer hot water supply connection must provide a minimum of 120°F to ensure the effectiveness of this cycle. Only the **SANITIZE + Allergen** and **SANITIZE With Oxi** cycles have been designed to meet the requirements of sanitizing effectiveness.

Using the washer

Wash Cycles - Continued

The cycles are optimized for specific types of loads. The chart below will help you match the items to be laundered with the best cycle settings. For optimal performance, select the cycle that most closely matches the items in your load. **Delay Start/Remote Start** is available on all cycles.

	Wash Cycles															
	Normal	Delicates	Towels	Bulky Items	Active Wear	Quick Wash	Whites	Rinse and Spin	Cold Wash	Heavy Duty*	Jeans*	Swim Wear*	Sanitize with Oxi*	Sanitize+ Allergen*	Power Clean	Self Clean
Wash Settings	Soil Level															
	Extra Heavy	•		•	•	•		•		•	•	•	•	•	•	•
	Heavy	•		•	•	•		•		•	•	•	•	•	•	•
	Normal	•	•	•	•	•	•	•	•	•	•	•				•
	Light	•	•	•	•	•	•		•	•	•	•				
	Extra Light	•	•	•	•	•	•		•		•	•				
	Wash Temperature															
	Extra Hot	•						•					•	•	•	•
	Hot	•	•	•	•			•		•		•				•
	Warm	•	•	•	•	•	•	•		•	•	•				•
	Cold	•	•	•	•	•	•	•		•	•	•				•
	Tap Cold	•	•	•	•	•	•	•		•	•	•				•
	Spin Selection															
	Max	•		•	•		•	•	•	•	•		•	•	•	•
	High	•		•	•		•	•	•	•	•	•	•	•	•	•
	Medium	•	•	•	•	•	•	•	•	•	•	•	•	•	•	•
	Low		•	•	•	•	•	•	•		•	•	•	•	•	•
	No Spin		•			•		•				•				
	Wash Options															
	Power Steam*	•		•	•		•					•	•		•	•
	Prewash* or Auto Soak*	•	•	•	•	•		•		•	•	•	•	•	•	•
	Time Saver	•	•	•	•	•		•								
	More Water		•	•	•		•	•	•	•	•	•				
	Extra Rinse	•	•	•	•	•	•	•	•	•	•	•	•	•	•	•
	Tumble Care*	•	•	•	•	•	•	•	•	•			•	•	•	•
	Soak Rinse for Sanitizer	•	•	•	•	•	•	•	•	•	•	•	•			•

This cycle is for periodic cleaning of the washer only. See the **Self Clean** section for more information.

• Available setting

Factory default setting

* Available from Downloaded cycles.

Using the washer

D Settings

Individual settings for soil level (**Level**), water temperature (**Temp**) and spin speed (**Spin**) can be set from the minimum to maximum. In general, the higher up the column, the more energy will be used.

Soil

Changing the **Soil** level increases or decreases the wash time to remove different amounts of soil.

To change the **Soil** level, press the **Soil** level pad until you have reached the desired setting. You can choose between Extra Light, Light, Normal, Heavy or Extra Heavy soil levels on most cycles.

Temp

Adjust to select the proper water temperature for the wash cycle. The **AutoSoak** and **PreWash** rinse water is always cold to help reduce energy usage and reduce setting of stains and wrinkles.

Follow the fabric manufacturer's care label when selecting the wash temperature.

To change the wash temperature, press the **Temp** pad until you have reached the desired setting. You can choose between Tap Cold, Cold, Warm, Hot or Extra Hot on most cycles. By design, to protect fabrics, not all wash temperatures are available for certain wash cycles. Extra Hot temperatures are enabled by the internal heater on models equipped with Steam capabilities.

NOTE: The first 10 seconds of the wash fill is always cold. This feature assists in conditioning the fabric and preventing stains from setting on garments.

Spin

Adjusting the **Spin** speed changes the final spin speed of the cycles. Always follow the garment manufacturer's care label when changing the **Spin** speed.

To change the **Spin** speed, press the **Spin** speed pad until you have reached the desired setting. You can choose between No Spin, Low, Medium, High or Max. Higher spin speeds are not available on certain cycles, such as **DELICATES** and **ACTIVE WEAR**.

Higher spin speeds remove more water from the clothes and will help reduce dry time, but may also increase the possibility of setting wrinkles on some fabrics.

NOTE: This washer features a **dBT™ (Dynamic Balancing Technology)** system. This patented onboard sensing technology enables real-time balancing of the spin cycle for each load, saving time and providing a quiet wash. This should lead to more consistent wash times and an overall reduction in noise and vibration. If the washer should experience any excessive noise, vibration or shaking, simply **Pause** the washer, open the door, and manually redistribute the load before restarting the cycle.

E Options

SMARTDISPENSE™ (on some models)

When selected, this feature will automatically add detergent to the wash, eliminating the need to add detergent for each load. See the **SmartDispense** section for details.

My Settings (on some models)

To save your favorite settings for a given cycle, set the desired options for Soil, Spin and Temp levels, extra rinse and other settings. Hold down the **My Settings** pad for 3 seconds. A beep will sound to indicate the selections for this cycle have been saved. You can choose to create **My Settings** for other cycles.

STEAM/POWER STEAM (on some models)

The steam feature adds steam into the washer before the wash cycle begins to assist with loosening stains on the **NORMAL**, **WHITES**, **TOWELS**, **BULKY Bedding**, **SANITIZE+Allergen** and **POWER CLEAN** cycles.

To use:

1. Press the **Power** pad to "wake up" the washer and select a wash cycle.
2. Use the SmartHQ App or press the **POWER STEAM** pad (on some models) to activate steam.
3. Press the **Start/Pause** pad.

WiFi (may be a shared pad with other options)

Press and hold the **WiFi*** pad for 3 seconds to activate. See the **WiFi Connect** section for details on how to get started with WiFi connection.

Using the washer

E Options

Delay Wash/Remote Start

You can delay the start of a wash cycle for up to 24 hours or remote start the washer by using the **Delay Wash/Remote Start** feature. Press to step by hours or hold to scroll the **Delay Wash** pad to set the amount of time you want to delay the start of the wash cycle. If you have connected your washer to WiFi, the first selection, "AP", can be selected to enable remote starting of your washer from the GE Appliance Smartphone app. Or, if you select a delay time in hours, the machine will count down and start automatically following this period. Press the **Start** pad once you have configured the **Delay Wash** to the proper setting to enable this feature. To cancel this option, simply power off and power on the controls.

NOTE: If you forget to fully close the door, a reminder signal will beep reminding you to do so.

NOTE: If you open the door when the delay is counting down, the machine will enter the pause state. You must close the door and press **Start** again in order to restart the countdown.

Time Saver (on some models)

This option reduces the overall washer cycle time by optimizing the wash, rinse and spin actions and/or gently raising the wash temperature to get clothes cleaned faster. Option is available on **NORMAL, WHITES, TOWELS, DELICATES, BULKY Bedding** and **ACTIVE WEAR** cycles. Total wash time will vary based on cycle chosen and options selected.

To use:

1. Turn power on and select a wash cycle which has **Time Saver** as an option.
2. Press the **Time Saver** pad to reduce the overall wash time.
3. Press the **Start/Pause** pad.

More Water (on some models)

This option adds approximately 3 gallons to the wash and rinse portions of the cycle. If the option is selected before the cycle starts, the water will be added from the beginning of the wash cycle and later to the rinse. If the option is selected during the wash portion, more water will be added at this point and later to the rinse. Likewise, if the **More Water** option is selected after the wash portion has completed, the washer will add more water to the rinse only. If wash and rinse have completed, the **More Water** pad will no longer be active.

ULTRAFRESH VENT System with ODORBLOCK™ (on GE Appliances and Profile models only)

The ULTRAFRESH VENT System with OdorBlock was designed to eliminate excess moisture in the washer following a wash cycle to help prevent odors from developing. This washer was designed to drain water at the end of the cycle more effectively. Following the wash cycle, the user can then choose to leave the door open or select the ULTRAFRESH VENT feature to assist with drying out the gasket and other areas of the washer. The OdorBlock system features multiple components which are manufactured with Microban® antimicrobial technology.* Microban is a safe and effective antimicrobial technology that will last the life of your washer. For more information, please visit www.microban.com/geappliances.

ULTRAFRESH VENT is available after the wash cycle is complete and you have removed your cleaned laundry. Once the door is closed, a notification tune will play and the **ULTRAFRESH VENT** pad LED will blink. Upon pressing the pad, ULTRAFRESH VENT will begin.

To select ULTRAFRESH VENT at any other point, power on the washer, ensure a cycle is not actively running, and remove any garments from the basket, then press and release the **ULTRAFRESH VENT** pad so that the notification tune plays and the **ULTRAFRESH VENT** pad LED begins to blink. Then press the **ULTRAFRESH VENT** pad again to start the feature.



During the operation of ULTRAFRESH VENT the door will remain locked and the washer will intermittently spin at low speeds for up to 8 hours. Profile models utilize a sensor to determine end time.

If garments are detected in the basket during ULTRAFRESH VENT, the washer will instead run **TUMBLE CARE** or **1 STEP WASH + DRY**, based on option availability for your model.

The ULTRAFRESH VENT feature may be cancelled at any time by pressing the **POWER** pad, turning the cycle knob, or pressing the **ULTRAFRESH VENT** pad.

Using the washer

E Options

SmartHQ App Enabled

There are several options that support your WiFi connected washer available through the SmartHQ App. Not only does this App enable you to receive over the air upgrades and updates to your washers software, but it unlocks special features for your washer. Among those features are **Adaptive SmartDispense**, **Adaptive My Settings** and **Stain Removal Guide**.



*Microban® is a registered trademark of Microban International, Ltd.

1 STEP WASH + DRY (on some models)

This option is available on all cycles except **Self Clean**.

The **1 STEP WASH + DRY** is intended for small loads only. Use when clothes need to be washed, dried and ready to wear or finished the next morning. This feature will tumble clothes and introduce a constant stream of air into the washer compartment upon completion of select wash cycles. Although the drying portion is set to 8 hours, the clothes can be removed at any time by pressing **Pause** or **Power** to cancel the cycle.

Tumble Care (on some models)

Freshly tumbles your garments periodically for up to 8 hours after the wash cycle is complete to lessen the setting of wrinkles and creases when you are not able to move clothing to the dryer right away.

At the end of the cycle, the display will scroll "END" and after ten minutes the **Tumble Care** will begin. It can be stopped at any time by pressing the **Power** pad.

PreWash (on some models)

Prewash is an extra wash before the main wash. Use it for heavily soiled clothes or for clothes with a care label that recommends prewashing before washing. Be sure to add liquid or powder high-efficiency detergent, or the proper wash additive to the prewash dispenser. Washers equipped with **SmartDispense** will automatically add the proper amount of detergent for prewash based on the load size.

PreWash must be selected prior to pressing **Start**.

The **PreWash** feature will fill the washer (adding the prewash detergent), tumble the clothes, drain and spin. Then the washer will run the selected wash cycle.

NOTE: In some special cycles, the prewash is selected automatically as the default. You can turn off this selection at any time. The main wash will use new detergent from the manual detergent compartment and from the SmartDispense tank (on some models).

AutoSoak (on some models)

For soaking your garments prior to the wash cycle. This option begins with a brief tumble and then proceeds to soak the clothes with water and detergent for a specified period of time. Once complete, the cycle will continue automatically. **AutoSoak** must be selected prior to pressing the start pad. The **AutoSoak** time will add an additional 15 minutes, 30 minutes, 1 hour or 2 hours to the overall wash time. High-efficiency detergent from the main wash compartment in the dispenser is used for the **AutoSoak** period and main wash cycle.

Soak Rinse (on some models)

Select this feature when laundry sanitizer is used. This feature is recommended for special case loads only, not for typical use. Press **Soak Rinse for Sanitizer** button to enable. An additional chime will occur and the cycle time will increase due to additional soaking time to activate the laundry sanitizer. To cancel the option, press the **Soak Rinse for Sanitizer** button again. **NOTE:** Fill the fabric softener compartment in the dispenser drawer with the recommended amount of laundry sanitizer.

Extra Rinse

This option allows for an extra rinse during a cycle to remove excess dirt and detergent from soiled loads. Press the **Extra Rinse** pad to select.

NOTE: On **RINSE & SPIN** cycle, a **drain and spin** cycle can be achieved by pressing the **Extra Rinse** pad until the LED is no longer illuminated.

Using the washer

E Options

Light (on some models)

The basket light will turn on and remain on for 5 minutes when the door opens, **Start/Pause** pad is pressed, or by pressing the **Light** pad. The basket light can be turned off by pressing the **Light** pad.

Sound

To change the loudness of the end of cycle signal and the press pad volume, press the **Sound** pad as many times as needed to reach the desired volume. On some models there are four sound levels including off, other models have Off/On with press and hold function.

Control Lock (Light-Control Lock pad) (depending on model)

You can lock the controls to prevent any selections from being made. Or you can lock or unlock the controls after you have started a cycle.

Children cannot accidentally start the washer by touching pads with this option selected.

To lock/unlock the washer, press and hold the **Control Lock/Light-Control Lock** pad for 3 seconds. A sound is made to indicate the lock/unlock status. The control lock icon on the display will light up when it is on.

NOTE: The **Power** pad can still be used when the machine is locked.

Appliance Communication

WiFi Connect (For customers in the United States only - GE Appliances and Profile models only)

Your washer is **GE Appliances WiFi Connect** enabled.

It is highly recommended that you connect your washer to WiFi to download the latest software, receive periodic updates and benefit from many of the extended features available through the SmartHQ App. Many of the AI features for your washer require connection to the SmartHQ App.

Visit geappliances.com/connect and enter your model number to show you the proper steps to connect your appliance.

Take special note of your washer's serial number and MAC ID address on the front of this manual.

Please visit GEAppliances.com/connect to learn more about connected appliance features, to learn what connected appliance App's will work with your smartphone.

WiFi Connectivity: For assistance with the appliance or the **ConnectPlus** network connectivity, please call GE Appliances at **800.220.6899**.

Scan here to get started.

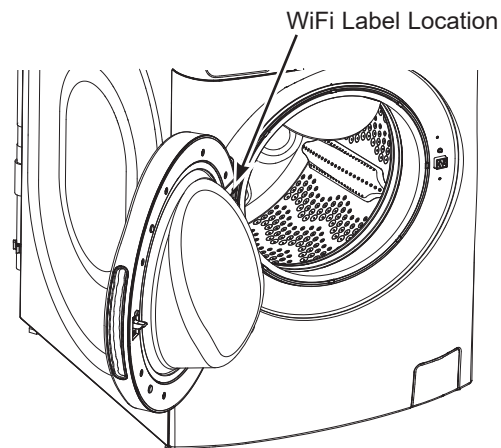

Using the washer

Dryer Control – Bluetooth® Pairing (on some models)

1. Power on both the **washer** and the **dryer** but do not start any cycles.
2. Press and hold the **Tumble Care** button on the **washer** for 5 seconds until the Bluetooth® LED (📶) starts to flash and you hear an audible tone.
3. Open and close the **dryer** door 3 times within 10 seconds to make it discoverable to the washer.
4. The washer will attempt to discover the dryer, the Bluetooth® icon will flash and both displays will blink “ - - - ”.
5. The Bluetooth® icon on the washer should illuminate solid signifying that the machines are now paired. The display on the washer will display “bt” once pairing is complete.
6. If the Bluetooth® units fail to pair, repeat above steps 1-5.
7. To unpair the machines, press and hold the **Tumble Care** button for 10 seconds or open and close the **dryer** door 3 times within 10 seconds.



Open and close
dryer door
3 times within
10 seconds

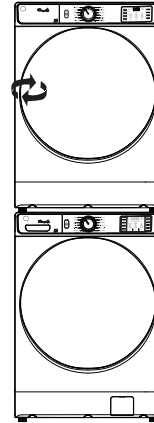

How to use the Dryer Control Feature (on some models)

1. Power on the **washer**.
2. Press and hold the **Dryer Control** button on the **washer** for 3 seconds to power on the **dryer**.
3. The **dryer's** cycle selection will flash to display the recommended sensor cycle that pairs to the last completed washer cycle as the **washer** display reads “drY”.
4. To use this cycle, press the **Dryer Control** button to start the **dryer**. The **dryer** can be paused by opening its door or pressing the **Dryer Control** button. To restart the **dryer** with its door closed, press the **Dryer Control** button again.
5. To select **Timed Dry** instead of the sensor dry cycle, press the **Timed Dry** button on the **washer** while the display says “drY”. Repeated presses of this button will step through preset **Timed Dry** times (default is 10 minutes).
6. Once you've selected the **Timed Dry** cycle's duration, press the **Dryer Control** button within 10 seconds to start the dryer.



Washer

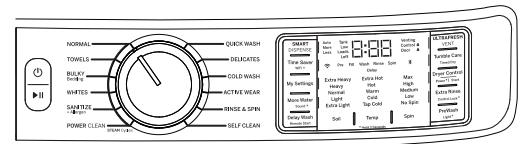

Dryer

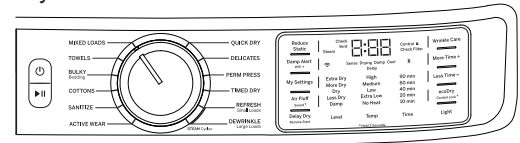

NOTE: Your **dryer's** control panel is fully functional even when you are using **Dryer Control** through the **washer**.

Powering off the **washer** will not power off the **dryer** when a dry cycle is in progress.



Using the washer

Dispenser Drawer

Slowly open the dispenser drawer by pulling it out until it stops. After adding laundry products, slowly close the dispenser drawer. Closing the drawer too quickly could result in early dispensing of the bleach, fabric softener or detergent.

You may see water in the detergent, bleach and fabric softener compartments at the end of the cycle. This is a result of the flushing/siphoning action and is part of the normal operation of the washer.

Do **NOT** put detergent packets in the dispenser drawer.

NOTE: Use only liquid or powder HE detergents and additives in the dispenser drawer. Laundry detergent packets should only be added directly to the wash basket following the manufacturer's directions.

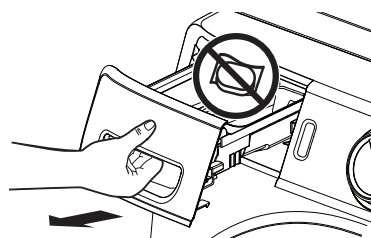

Use only HE High-Efficiency detergent



SmartDispense™ (on some models)

When selected, this feature will automatically add detergent to the wash, eliminating the need to add detergent for each load.

The detergent amount selection on the control panel will default to **AUTO** when first powering up the washing machine. When **AUTO** is selected, the amount of detergent needed for each laundry load will automatically be determined based on the size of the load the machine senses.

For **AUTO**, the washer will dispense approximately 1.5 oz of detergent for an 8 lb normal load. For other loads, it will adjust proportionally based on the size of load and garment type. If you select **LESS**, the amount of detergent will be reduced by 40%. This may be desired for higher concentrate detergents or if you have very soft water. For heavily soiled loads, you may want to select **MORE** to add 40% more detergent than the **AUTO** level. You can set the brand/type of detergent in the SmartHQ App so that the washer can make adjustments based on detergent manufacturers recommendations.

NOTE: Not all cycles will allow the use of the SmartDispense feature. If the light is not illuminated and pressing the **SMART DISPENSE** pad results in a beeping tone, then SmartDispense is not allowed for the cycle that has been selected. Detergent will need to be added directly to the detergent compartment for these cycles.

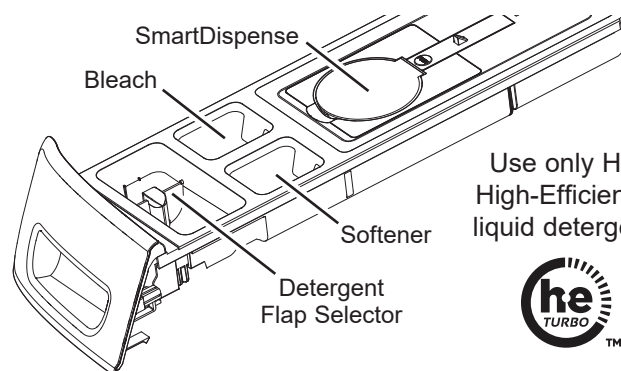

Use only HE High-Efficiency liquid detergent



If it is desired to manually add detergent for a particular load:

1. Press the **SMART DISPENSE** pad on the control panel until its light turns off which indicates the SmartDispense feature has been turned off.
2. Set the flap in the detergent compartment to the type of detergent to be used - Powder or Liquid. See the **Detergent Compartment** section.
3. Add the desired amount of detergent into the detergent compartment.

If the display indicates that the SmartDispense tank is estimating there is insufficient detergent to wash a load, the SmartDispense light will flash. The washer can still run a cycle, but it suggested that you add detergent in the manual detergent compartment or refill the SmartDispense tank.

Prewash Compartment (on some models)

Only use the prewash compartment if you are selecting the **PreWash** cycle for heavily soiled clothes. Add measured detergent or prewash additive to the back left prewash compartment of the dispenser drawer.

- Detergent or prewash additive is flushed from the dispenser in the **PreWash** (if selected).
- Detergent usage may need to be adjusted for water temperature, water hardness, size and soil level of the load. Avoid using too much detergent in your washer as it can lead to over sudsing and detergent residue being left on the clothes.

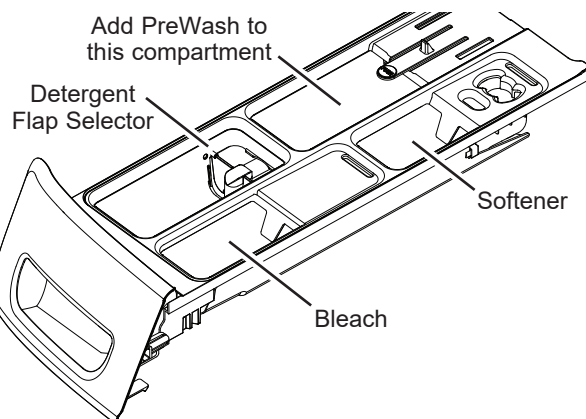

Using the washer

On models with SmartDispense:

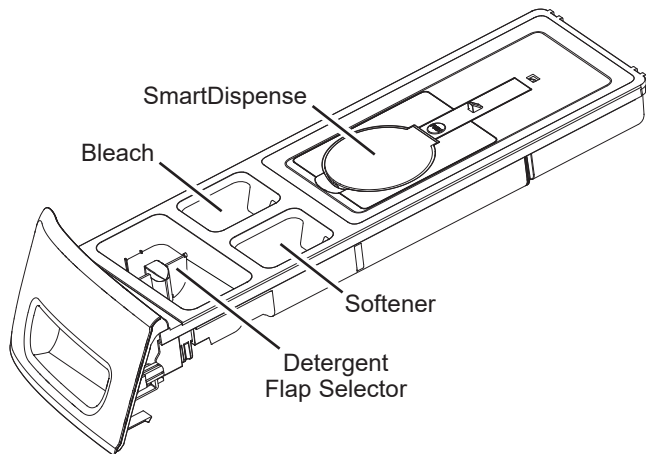

On models without SmartDispense:

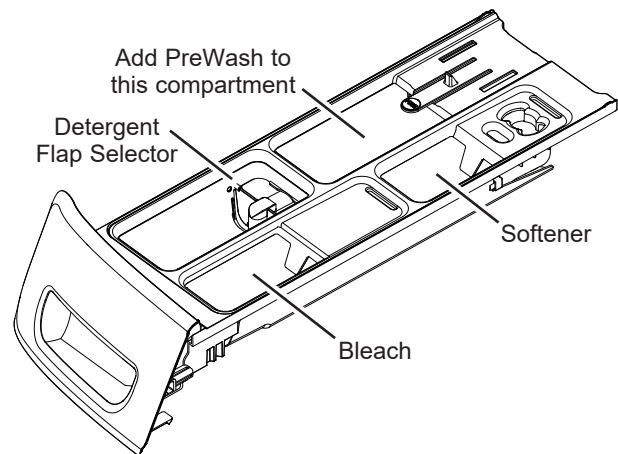

Detergent Compartment

Only use high-efficiency detergent in this washer. Do NOT fill high-efficiency detergent over the MAX line. Use detergent manufacturer's recommended amount.

- **Powder Detergent** – Lift the flap up for powder detergent. This must be done to dissolve and flush detergent properly. Follow the detergent manufacturer's instructions when measuring the amount of powder detergent to use.
- **Liquid Detergent** – Keep the flap down for liquid detergent. This retains the liquid detergent until it automatically flushes at the start of the wash cycle. Follow the detergent manufacturer's instructions when measuring the amount of liquid detergent to use.

Detergent usage may need to be adjusted for water temperature, water hardness, size and soil level of the load. Avoid using too much detergent in your washer as it can lead to oversudsing, detergent residue being left on the clothes, and could extend wash times.

Do not put clumped detergent in the dispenser. Clumped detergent can cause a leak.

Do **NOT** put detergent packets in the dispenser drawer.

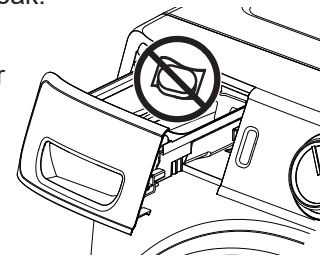

Liquid Bleach Compartment

If desired, measure out the recommended amount of liquid bleach, not to exceed 1/3 cup (80 ml) and pour into the compartment labeled "LIQUID BLEACH" marked with this symbol .

It is recommended to use High-Efficiency (HE) bleach in this front-load washer.

Do not exceed the maximum fill line. Overfilling can cause early dispensing of the bleach which could result in damaged clothes.

NOTE: Do not use powdered bleach or laundry detergent/additive packets in the dispenser.

Fabric Softener Compartment

If desired, pour the recommended amount of liquid fabric softener into the compartment labeled "FABRIC SOFTENER".

Use only liquid fabric softener in the dispenser.

Do not exceed the maximum fill line. Overfilling can cause early dispensing of the fabric softener, which could stain clothes.

NOTE: Do not pour fabric softener directly on the wash load.

NOTE: The fabric softener compartment will be siphoned in the final rinse of the wash cycle. This compartment can also be used to accommodate other liquid rinse aids such as sanitizers and fabric enhancing liquids. The use of these other products must be certified by the liquid manufacturer for safety in the use of a residential washing machine and combination washer/dryer. Please check carefully, as certain liquids may invalidate the warranty on your Washer.

Consumer Help Indicator

Your washer is equipped with Consumer Help Indicator (CHI). CHI is our way to communicate a simple remedy for some situations that you can perform without the need to call for service. The chart below describes the helpful messages you may notice scrolling on your display when you return to start another load. These messages will provide simple remedies you can quickly perform.

<p>Spin light blinking</p>	<p>If an out-of-balance condition is detected by the washer, the Spin light will blink during the remaining portion of the cycle and will stay illuminated for a short time after cycle completion. When this occurs, the washer is taking actions to correct the out-of-balance condition and complete the cycle normally. In some cases, the washer may not be able to balance the load and spin up to full speed. If you notice the load is more wet than normal at the end of the cycle, redistribute the load evenly in the wash basket and run a Drain & Spin cycle. (See Extra Rinse in the Using the washer - Options section for details.)</p>
<p>"H2O SUPPLY" (Water not entering washer)</p>	<p>Check your house water supply. Did you forget to turn on one or both supply valves after installation or coming back from vacation? As soon as the message starts to scroll, the washer will initiate a 4 minute lock-out period. The washer controls won't respond/change during this time. After the 4 minutes, you can begin your cycle again. If you try to bypass the lock-out period by unplugging the washer, the 4 minute timer will start over again.</p>
<p>"CAnCELEd"</p>	<p>"CAnCELEd" may scroll on the display if the machine was paused for longer than 24 hours or if the machine has stopped itself before the cycle completed due to certain errors. As soon as the message starts to scroll, the washer will initiate a 4 minute lock-out period. The washer controls won't respond/change during this time. After the 4 minute period, you can begin your cycle again. If you try to bypass the lock-out period by unplugging the washer, the 4 minute timer will start over again. If the problem persists, call GE Appliances at 800.GE.CARES (800.432.2737) for service.</p>
<p>"door"</p>	<p>"door" will be shown on the display if you try to start a cycle when the door is not fully closed. "door" will also be shown on display if 3 cycles have been started without opening the door. The washer will not start another cycle until the door is opened. In either circumstance, try opening and closing the door, and then starting a new cycle. If the problem persists, call GE Appliances at 800.GE.CARES (800.432.2737) for service.</p>

Loading

Always follow fabric manufacturer's care label when laundering.

Sorting Wash Loads

Sort by color (whites, lights, colors), soil level, fabric type (sturdy cottons, easy care, delicates) and whether the fabric produces lint (terry cloth, chenille) or collects lint (velveteen, corduroy). Wash lint producers such as cotton towels and socks separate from lint collectors including synthetic garments and dress pants.

⚠ WARNING  - Fire Hazard

- DO NOT** wash fabrics soiled with flammable liquids or cleaning solvents.
- No washer can completely remove oil.
- DO NOT** dry anything that has been soaked in or spotted with any type of oil.
- DO NOT** reach into the washer until all moving parts have stopped.
- Doing so can result in death, explosion, fire or amputation.

Loading the Washer

The wash drum may be fully loaded with loosely added items.

To add items after the washer has started, press **Start/Pause** and wait until the door is unlatched. The washer may take up to 30 seconds to unlock the door after pressing **Start/Pause**, depending on the machine conditions. Do not try to force open the door when it is locked. After the door unlocks, open gently. Add items, close the door and press **Start/Pause** to restart.

Loading Examples

Load Type	Mixed Load	Towels & Sheets	Delicates*	Work Wear	Small Load (2-5 items)
Suggested Cycle	NORMAL	TOWELS	DELICATES	JEANS	Quick Wash
Load Contents	6 Dress Shirts 3 Dress Pants 3 Poly T-Shirts 3 T-shirts 4 Pairs of Shorts 6 Boxers OR 6 T-shirts 4 Sweatpants 4 Sweatshirts 2 Hoodies 7 Pairs of Socks	4 Pillowcases 2 Hand Towels 2 Flat Sheets/ 2 Fitted Sheets 2 Bath Towels/ 4 Washcloths OR 2 Flat Queen-Sized Sheets 2 Fitted Queen-Sized Sheets 4 Pillowcases	7 Bras 7 Panties 3 Slips 2 Camisoles 4 Nightgowns *Using a nylon mesh bag for small items is recommended.	4 Jeans 5 Work Shirts 3 Work Pants	1 Pair Casual Pants 2 Casual Shirts OR 3 Soccer Uniforms

Care and cleaning

Water Supply Hoses

Periodically inspect all water inlet hoses for water leaks, wear, cuts, corrosion, and bulges. Replace all hoses immediately if any sign of these failures appear. All hoses should be replaced every 5 years of use to reduce risk of hose failures and possible water damage. When replacing hoses, refer to the Installation Instructions for proper installation. **DO NOT** overtighten or cross thread fittings. **DO NOT** allow the hose to rub against sharp objects, become kinked, or become over stretched. Always ensure hose rubber gaskets are installed and free from leaks when pressurized.

Exterior

Immediately wipe off any spills. Wipe or dust spills or washing compounds with a damp cloth. Washer control panel and finishes may be damaged by some laundry pretreatment and stain remover products. Apply these products away from the washer. The fabric may then be washed and dried normally. Damage to your washer caused by these products is not covered by your warranty. Do not hit surface with sharp objects.

Interior

Dry around the washer door opening, flexible gasket (including attached hoses) and door glass. These areas should always be clean to ensure a watertight seal. You will notice if you regularly use the ULTRAFRESH VENT System that this will not be required as often. It is recommended to rinse the washer at least once per month with 1 cup of bleach (or other commercially available product manufactured for this purpose, such as Tide® Washing Machine Cleaner) poured directly into the basket without clothes and using the **Self Clean** Cycle.

Self Clean

To clean the interior of the washer, select the **SELF CLEAN** feature on the control panel. This **Self Clean** cycle should be performed, at a minimum, once per month or about every 40 wash cycles. This cycle will use more water, in addition to bleach, to control the rate at which soils and detergents may accumulate in your washer.

NOTE: Read the instructions below completely before starting **Self Clean** cycle.

1. Remove any garments or objects from the washer and ensure the washer basket is empty.
2. Open the washer door and pour one cup or 250 ml of liquid bleach or other washing machine cleaner into the basket.
3. Close the door and select the **SELF CLEAN** cycle. Push the **Start** pad.
4. When the **Self Clean** cycle is working, the display will show the estimated cycle time remaining. The cycle will complete in about 90 minutes. Do not interrupt the cycle.



5. After the cycle is complete (on some models), the washer will automatically start an ULTRAFRESH VENT operation so that the door can remain closed until the next time you use the washer.

If for any reason the cycle needs to be interrupted, the door will not open immediately. Forcing open the door at this stage may cause water to flood. The door will open after the water is drained to a level where it would not flood the floor.

Self Clean may be interrupted by pressing the **Start** pad in between cycles. A power outage in the house might also interrupt the cycle. When the power supply is back, the **Self Clean** cycle resumes where it had stopped. When interrupted, be sure to run a complete **Self Clean** cycle before using the washer. If the **Power** pad is pressed during **Self Clean**, the cycle will be lost.

IMPORTANT:

- Run **Self Clean** with one Cup (250 ml) of bleach once a month.
- After the completion of a **Self Clean** cycle, the interior of your washer may have a bleach smell.
- It is recommended to run a **RINSE & SPIN** or a light color load after the **Self Clean** cycle.

Door Gasket

Open the washer door. Using both hands, press down the door gasket.

While holding down the door gasket, inspect the interior fold. Remove any foreign objects if found trapped inside this gasket.

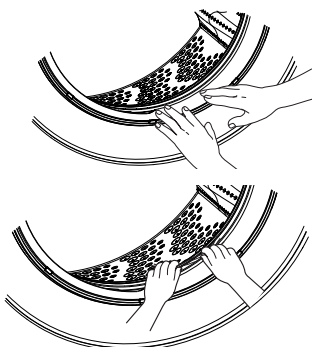

Make sure there is nothing blocking the holes behind the gasket.

When you are finished cleaning the door gasket, release it and the gasket will return to the operating position.



Care and cleaning

Dispenser Drawer Area

Detergent and fabric softener may build up in the dispenser drawer. Residue should be removed once or twice a month.

- Remove the drawer by first pulling it out until it stops. Then reach back into the rear of the drawer cavity and press down firmly on the lock tab, pulling out the drawer.
- Rinse the drawer with hot water to remove traces of accumulated laundry products.
- To clean the drawer opening, use a small brush to clean the recess. Remove all residue from the upper and lower parts of the recess.
- Replace the dispenser drawer.
- To reduce buildup in the Dispenser Drawer area:

Use only HE
High-Efficiency
detergent



On models with
SmartDispense:

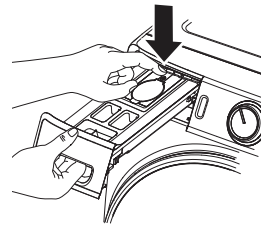

On models without
SmartDispense:

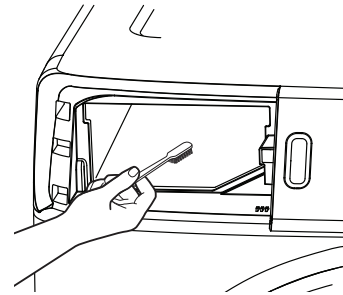
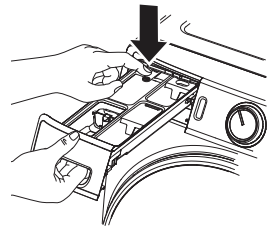

Pump Filter

Due to the nature of the front-load washer, it is sometimes possible for small articles to pass to the pump. The washer has a filter to capture lost items so they are not dumped to the drain. To retrieve lost items, clean out the pump filter.

1. Using a small flathead screwdriver or coin, open the access door.
2. Place a shallow pan or dish under the pump access door and towels on the floor in front of the washer to protect the floor. It is normal to catch about a cup of water when the filter is removed.
3. Pull down the pour spout.
4. Turn the pump filter counterclockwise and remove the filter slowly, controlling the flow of the draining water.
5. Remove the filter and clean the debris from the filter.
6. Replace the filter and turn clockwise. Tighten securely.
7. Flip up the pour spout.
8. Close the access door by hooking the bottom tabs first, then rotating the access door shut.

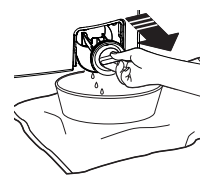
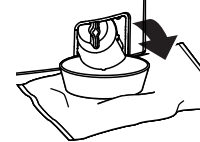
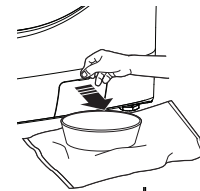

Video

Scan this code to watch a video on this topic.

Moving and Storage

Ask the service technician to remove water from drain pump and hoses. Do not store the washer where it will be exposed to the weather. When moving the washer, the tub should be kept stationary by using the shipping bolts removed during installation. See Installation Instructions in this manual. If these parts are not available, they can be ordered by visiting our Website at GEApplianceparts.com or by calling GE Appliances at 877.959.8688. In Canada, visit your local GE Appliances parts distributor or call 800.661.1616 or GEAppliances.ca/en/products/parts-filters-accessories.

Long Vacations

Be sure water supply is shut off at faucets. Drain all water from hoses and water filter pump area if weather will be below freezing.